

American Whirlpool® 200 Series Manual



IMPORTANT SAFETY WARNINGS

SAVE THESE INSTRUCTIONS

NOTE: When installing and using this equipment, basic safety precautions should always be taken to reduce the risk of electrical shock, to ensure safe usage, and to safeguard the user's health. Failure to follow instructions and warnings contained in this Owner's Manual, Installation Guide and on the spa/swim spa itself may result in severe personal injury, including death, as well as property damage.

WARNING:

Children should not use spas or hot tubs without adult supervision.

WARNING:

Do not use spas or hot tubs unless all suction guards are installed to prevent body and hair entrapment.

WARNING:

Pregnant, or possibly pregnant, women should consult a physician before using a spa or hot tub.

WARNING:

People with infectious diseases should not use a spa or hot tub.

WARNING:

To avoid injury, exercise care when entering or exiting the spa or hot tub.

WARNING:

Do not use drugs or alcohol before or during the use of a spa or hot tub to avoid unconsciousness and possible drowning.

WARNING:

People using medications and/or having an adverse medical history should consult a physician before using a spa or hot tub.

WARNING:

Water temperature in excess of 100°F (38°C) may be injurious to your health.

WARNING:

Before entering the spa or hot tub, measure the water temperature with an accurate thermometer.

WARNING:

Do not use a spa or hot tub immediately following strenuous exercise.

WARNING:

Prolonged immersion in a spa or hot tub may be injurious to your health.

WARNING:

Maintain water chemistry in accordance with manufacturer's instruction.

WARNING:

Do not permit electric appliances (such as a light, telephone, radio or television) within 5 feet (1.5m) of the spa or hot tub.

WARNING:

The use of alcohol or drugs can greatly increase the risk of fatal hyperthermia in hot tubs and spas.

TABLE OF CONTENTS

IMPORTANT SAFETY WARNINGS	1	Electrical Configurations.....	21
TABLE OF CONTENTS	2	Wi-Fi.....	21
IMPORTANT SAFETY INSTRUCTIONS	3	About.....	21
DOS AND DON'TS OF SPA CARE.....	5	Feature Operations	22
Hyperthermia	5	Jet Selector Valves (Divertor Valves)	22
SPA INSTALLATION	6	Air Control Valves	22
European Spas.....	6	Water Feature/Waterfall Control Valve	22
SPA Site and Positioning.....	6	in.stream2 Audio System.....	22
Outdoor Installation	6	in.touch 2 Wi-Fi System	23
Indoor Installation.....	6	WATER BALANCE	30
Thermal Creep.....	7	Water Chemistry	30
SPA SYSTEM COMPONENTS	8	Start-Up Procedures	30
SPA COMPONENTS	9	Water Quality	30
JETS AND AIR CONTROLS	10	pH Control.....	31
Jets.....	10	Total Alkalinity	31
Cleaning or Replacing Jets.....	10	WATER TREATMENT	32
Cleaning Jets.....	10	Sanitizers	32
Air Controls.....	11	Ozone	33
ELECTRICAL INFORMATION	12	UV.....	33
Important Safety Instructions.....	12	Water Testing	34
GFCI.....	12	SPA CARE	36
Residual Current Device.....	12	Filter Maintenance	36
Installation Options	12	Spa Surface Care	36
VOLTAGE/AMPERAGE CHART:.....	14	Spa Pillow Care	36
START UP PROCEDURES	16	Spa Cabinet Care	36
Priming Your Spa	16	Spa Cover Care	37
in.k500 Gecko Control Panel	17	Draining the Spa	37
Main Screen.....	17	Winterizing	37
Start or Stop Accessories	18	TROUBLESHOOTING	39
Water Temperature	18	Heating System.....	40
Settings.....	18	Water System	40
Water Care.....	19	Electrical System.....	40
Water Care Modes	19	Error Messages & Codes.....	41
Filtration System	19	SAFETY SIGN	43
Modifying Schedules	20	LIMITED WARRANTY SUMMARY	43
Audio	20	COPYRIGHTS AND TRADEMARKS	44
Date & Time	20	NOTES	45
Keypad Settings.....	20		

IMPORTANT SAFETY INSTRUCTIONS

READ AND FOLLOW ALL INSTRUCTIONS

- WARNING** - To reduce the risk of injury, do not allow children to use spa unless they are closely supervised at all times.
- A wire connector is provided on this unit to connect a minimum 6 AWG (5.15 mm²) solid copper conductor between this unit and any metal equipment, metal enclosures of electrical equipment, metal water pipe or conduit within 5 feet (1.5m) of the unit.
- (For cord-connected/convertible units)**
DANGER - Risk of injury.
 - Replace damaged cord immediately.
 - Do not bury cord.
 - Connect to a grounded, grounding type receptacle only.
- DANGER** - Risk of Accidental Drowning. Extreme caution must be exercised to prevent unauthorized access by children. To avoid accidents, ensure that children cannot use this spa unless they are supervised at all times.
- DANGER** - Risk of injury. The suction fittings in this spa are sized to match the specific water flow created by the pump. If you must replace the suction fittings or the pump, be sure the flow rates are compatible. Never operate spa if the suction fittings are broken or missing. Never replace a suction fitting with one rated less than the flow rate marked on the original suction fitting.
- DANGER** - Risk of Electric Shock. Install at least 5 feet (1.5m) from all metal surfaces. As an alternative, a spa may be installed within 5 feet (1.5m) of metal surfaces if each metal surface is permanently connected by a minimum 6 AWG (5.15 mm²) solid copper conductor to the wire connector on the terminal box that is provided for this purpose.
- DANGER** - Risk of Electric Shock. Do not permit any electric appliance (such as a light, telephone, radio or television) within 5 feet (1.5m) of the spa.
- WARNING** - To reduce the risk of injury:
 - The water in a spa should never exceed 104°F (40°C).. Temperatures between 100°F (38°C) and 104°F (40°C) are considered safe for a healthy adult. Lower temperatures are recommended for young children and when spa use exceeds 10 minutes.
 - Since excessive water temperatures have a high potential for causing fetal damage during the early months of pregnancy, pregnant or possibly pregnant women should limit spa water temperatures to 100°F (38°C).
 - Before entering spa, measure the water temperature as water temperature regulating devices vary.
 - The use of alcohol, drugs, or medication before or during spa use may lead to unconsciousness with the possibility of drowning.
 - Obese persons and persons with a history of heart disease, low or high blood pressure, circulatory system problems, or diabetes should consult a physician before using a spa.

f. Persons using medication should consult a physician before using a spa since some medication may induce drowsiness while other medication may affect heart rate, blood pressure, and circulation.

SAVE ALL INSTRUCTIONS

NOTE: Check with your state/local code enforcement officer to determine electrical code requirements and compliance. Use a qualified licensed electrician to complete all final spa electrical connections.

Caution: Risk of electrical shock. Read and follow all instructions.

TO AVOID RISK OF ELECTRICAL SHOCK:

1. A green colored terminal or a terminal marked G, GR, Ground, Grounding, or the international symbol  is located on the side of the supply terminal box or compartment. This terminal must be connected to the grounding means provided in the electric supply service panel, using a continuous copper wire equivalent in size to the circuit conductors supplying this equipment.
**IEC Publication 60417, Symbol 5019.*
Never use aluminum wire.
2. At least two lugs marked "BONDING LUGS" are provided on the external surface or on the inside of the supply terminal box or compartment. Connect the local common bonding grid (house-hold ground) in the area of the hot tub or spa to these terminals, using an insulated or bare copper conductor not smaller than No. 6 AWG.
3. All field-installed metal components such as rails, ladders, drains or similar hardware located within 5 ft (1.5m) of the spa or hot tub shall be bonded to the equipment grounding bus with copper conductors only, no smaller than No. 6 AWG.
4. **Never** connect unit to a power supply with a load controller.
5. Install spa in position which provides drainage of electrical component compartments.
6. The electrical supply for this product must include a suitably rated switch or circuit breaker to open all ungrounded supply conductors. This disconnecting means must be readily accessible for operation but installed at least 5 feet

(1.5m) from the spa. All electrical connections should comply with local regulations.

DOS AND DON'TS OF SPA CARE

Do:

- **Save these instructions!**
- Replace the cover immediately after use.
- Keep the cover locked when spa is not in use.
- Be aware of the dangers of a wet and slippery surface. Use caution when entering and exiting your spa.
- Have a licensed electrician or certified technician make all final electrical connections.
- Replace worn, frayed or broken electrical cords.
- Keep the water chemistry correctly balanced. Untreated spa water will cause problems with your spa and equipment as well as being a health risk.
- Clean the spa filter weekly or as needed.
- Position the spa so that all sides remain accessible for maintenance.
- Use a bathing cap for long hair.
- Refer to information on hyperthermia.
- Use only authorized spa care products for the best performance and to keep the water properly balanced.

Don't:

- Use the spa at 104°F (40°C) for long periods of time (more than 30 minutes).
See Hyperthermia, next column.
- Use an extension cord to power your spa.
- Allow anyone to stand on the spa cover. It is not designed to support weight.
- Power the spa unless it is filled with water 5-6 inches below top of spa lip.

- Operate the pump on high speed for extended periods of time with the cover in place. Extended operation can cause heat build-up and interfere with spa operation.

HYPERTHERMIA

The causes, symptoms, and effects of hyperthermia may be described as follows: hyperthermia occurs when the internal temperature of the body reaches a level several degrees above the normal body temperature of 98.6°F (37°C). The symptoms of hyperthermia include an increase in the internal temperature of the body, dizziness, lethargy, drowsiness, and fainting. The effects of hyperthermia include:

- a. Failure to perceive heat
- b. Failure to recognize the need to exit spa or hot tub
- c. Unawareness of impending hazard
- d. Fetal damage in pregnant women
- e. Physical inability to exit the spa or hot tub
- f. Unconsciousness resulting in the danger of drowning

WARNING - The use of alcohol, drugs, or medication can greatly increase the risk of fatal hyperthermia.

SPA INSTALLATION

The electrical supply for this product must include a suitably rated switch or circuit breaker to open all ungrounded supply conductors to comply with Section 422-20 of the National Electrical Code ANSI/NFPA70-1987. The disconnecting means must be accessible but installed at least 5 feet (1.5 m) from the spa water. All electrical connections should comply with article 680-D of the NEC.

EUROPEAN SPAS

The appliance should be supplied through a residual current device (RCD) with a rated tripping current not exceeding 30 mA. Means for disconnection must be incorporated in the fixed wiring in accordance with the wiring rules. Parts containing live parts, except parts supplied with safety extra-low voltage not exceeding 12 V, must be inaccessible to a person in the bath. Earthed appliances must be permanently connected to fixed wiring.

SPA SITE AND POSITIONING

Locate the spa on solid, level foundation or flooring, keeping in mind the weight of the filled spa in excess of 3,968lbs (1.800 kg) on some models. If you have any doubts about the load bearing ability of your chosen site, contact an architect/building contractor. The entire perimeter of the spa cabinet and spa bottom must be evenly supported. If your spa is installed outdoors, we recommend you provide a concrete pad for the spa to rest on 8ft x 8ft x 4in (2.5m x 2.5m x 10cm). **Failure to provide a level surface could structurally damage your spa and void the warranty.** The spa must be installed to allow access for service and maintenance on all four sides; therefore, below grade level or below deck installation is not recommended.

OUTDOOR INSTALLATION, Consider the following:

1. Local codes pertaining to fencing.
2. Local electrical and plumbing codes.
3. View from your house.
4. Wind direction.
5. Exposure to sunlight.
6. Distance to trees (twigs, leaves and shade).
7. Dressing and bathroom location.
8. Storage area for equipment and chemicals.
9. Location to facilitate adult supervision.
10. Landscaping and nighttime lighting.
11. Accessibility to equipment.
12. Power supply location and foot traffic.

INDOOR INSTALLATION, Consider the following:

1. Indoor spas promote high humidity. Using ventilation fans or commercial grade dehumidifiers will help to reduce humidity.
2. **Floor drains must be provided near the spa to drain off water that may cause falls and/or water damage.**
3. Floor area should be flat with a non-skid finish. Carpeting is not recommended.
4. Walls/ceilings should be made of materials able to withstand high humidity.
5. Floor load bearing capacities must be able to support the concentrated spa weight.
6. Spas should be double checked for leaks before installing to avoid possible water damage. Dealer installation may include this service.
7. Indoor sun rooms can maintain high ambient temperatures which may effect the spa water temperature. It is NOT recommended that you operate your filter cycles for longer than 4 hours per day under these conditions.

8. For units for use in other than single-family dwellings, a clearly labeled emergency switch shall be provided as part of the installation. The switch shall be readily accessible to the occupants and shall be installed at least 5 feet (1.52 m) away, adjacent to, and within sight of the unit.

IMPORTANT: Proper drainage must be provided to keep base dry, especially if installed below ground/in a pit.

WARNING: ACCESS TO THE SWIM SPA SHOULD BE CONTROLLED IN ACCORDANCE WITH ALL APPLICABLE NATIONAL AND LOCAL CODES. IN SOME LOCATIONS THIS MAY INCLUDE AN APPROVED FENCE WITH SELF-CLOSING, SELF-LOCKING GATE AND/OR A LOCKABLE SAFETY HARDCOVER FOR OUTDOOR USE AND A LOCKABLE DOOR AND/OR SAFETY HARDCOVER FOR INDOOR USE.

THERMAL CREEP

Your spa is manufactured with energy-efficient components and systems that capture heat generated by the equipment, then transfer that heat back to the spa water. In warmer weather or in situations with extended run times, "Thermal Creep" may occur. Thermal Creep is a condition whereby the actual water temperature is higher than the set temperature. To manage "Thermal Creep" you may:

- Vent your cover. Newer covers have removable center seal padding. To remove this padding, open the Velcro on one side of the vinyl pouch and slide the white padding out. If your spa does not have removable center seal padding, you may instead place a folded cloth about $\frac{3}{4}$ " (2cm) thick under all four corners of the cover before you lock it down. Opening

the cover at night will also quickly cool the water down if desired.

- Open all air controls
 - Set your filtration cycles to run during the cooler times of the day or at night
 - Reduce the length of your filter cycles
 - Visit your local dealer for additional guidance
- Thermal Creep only occurs in well-insulated hot tubs. It is not an indication that something is wrong with your spa or its equipment.

Danger: Electrical shock risk. Install at least 5 feet (1.5m) from all metal surfaces

SPA SYSTEM COMPONENTS

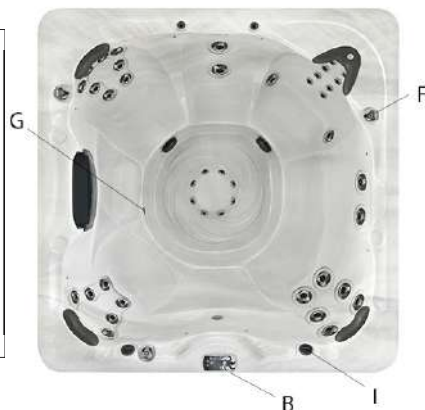

- A. Filter Skimmer/Weir:** Removes floating debris from the water surface, provides a water return path to equipment, and houses water filter element.
- B. Topside Control Panel:** Used to control temperature setting, pump for jets, and light.
- D. Manufacturer's Identification Label:** Contains identification information for warranty service (serial number, model number, etc.) and electrical information (amperage rating and amperage requirements).
- E. Equipment Pack Service Panel (no user serviceable parts):** Spa support system consisting of 2-speed pumps, heater, and associated electrical controls are inside this front panel (not shown).
- F. Air Controls:** Increases or decreases air entering the jets. Close during heating for maximum efficiency.
- G. Digital/Fiber Optic Lighting:** Lighting system that displays multiple colored lights in pre-programmed random, solid or alternating colors (not shown).
- I. Stereo/Speakers**
- J. Drain Access:** (Adjacent to the equipment service panel) Spa drain faucets.

SPA COMPONENTS

Reference only. Equipment is not always as shown.

ENGLISH

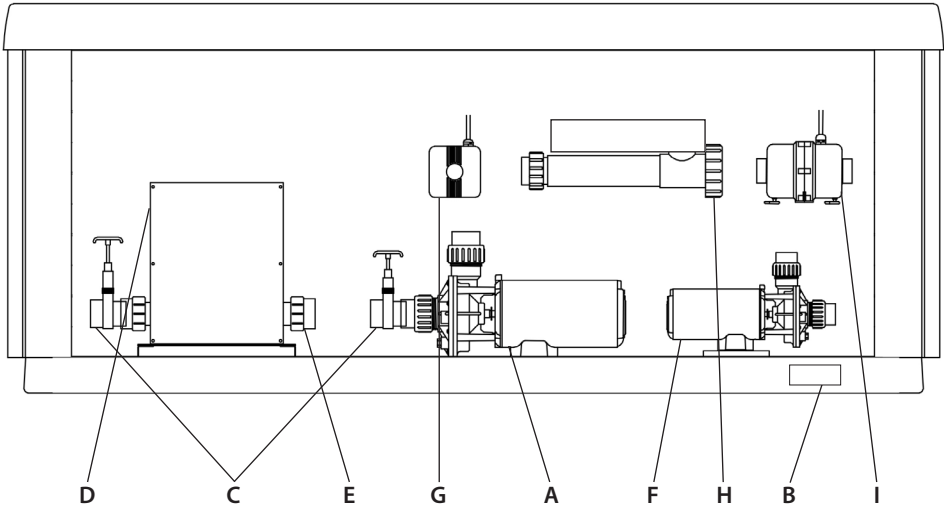

A. Pumps (one pump or more, depending on model): Low speed for efficient water circulation during filtration and heating; high speed for maximum action of the jets. The pump functions are activated by topside controls.

B. Manufacturer's Identification Label: Contains identification information for warranty service (serial number, model number, etc.) and electrical information (ampere rating and ampere requirements).

C. Slice Valve: Used to shut off water flow from the spa to the equipment while servicing. Quantity will vary depending on model. All should be open during normal operations.

D. Electrical Connections: Electrical inputs/wires for the unit connect here.

E. Heater Assembly: Thermostatically controlled and equipped with an overheat safety shut-off.

F. Circ Pump (Optional)

G. Ozone Generator (Optional)

H. UV System (Optional)

I. Blower (Optional)

Note: No consumer serviceable parts. Do NOT attempt to service any of these components yourself. Contact your dealer for assistance.

JETS AND AIR CONTROLS

JETS

All spa jets are individually engineered to provide a unique hydro-massage.

Depending on the model, your spa will have a combination of the following jets.

Swim Spa Jets

Swim spa jets are designed to produce a smooth flow of water with high output to create a consistent swim stream. Whether you want to swim or walk/jog against the force of the jets, you will find the flow of water deep enough and swift enough to meet your individual needs.

Hydrotherapy Area Jets

All spa jets are individually engineered to provide a unique hydro-massage.

Depending on the model, your spa will have a combination of the following jets.

Directional Jets

Positioned to focus on large muscle groups, these jets deliver a concentrated, high volume stream of water for a deep massage. Each jet is fully adjustable, allowing users to set the water flow to the most comfortable setting. Nozzle can be rotated to target sore muscles.

Rotating Jets

Positioned to focus on muscle tension zones, these jets deliver a spinning V-shaped water stream for a gentle, pulsating massage. Each jet is fully adjustable, allowing for comfortable water flow settings for everyone to enjoy.

Euro Jets

Positioned in the foot well or shoulder areas, these jets deliver a penetrating massage to

dissolve tension. This jet may be the entry point for ozone produced during automatic filtration and therefore it is not adjustable.

Note: Ozone production is stopped when functions are activated on control panel.

CLEANING OR REPLACING JETS

Hard water can cause calcium/mineral buildup that can restrict or bind the jets. A jet consists of a face plate and a nozzle. Rotate these parts weekly and remove/clean to ensure free movement, including the aurora cascades jets.

NOTE: It is not necessary to drain the spa to clean or remove the jets.

Rotating Jets

- Rotate the jet face left and right
- Return face plate to full open position
- Turn the jets on high speed
- Twist the nozzle left and right
- Rotate the nozzle in the socket

NOTE: If the jet insert disengages from the spa housing, see steps to reinstall below.

CLEANING JETS

- To **REMOVE** the jet insert, use the palm of your hand to exert pressure on the face of the jet. Turn counterclockwise until the jet 'clicks'. Gently pull the jet assembly from the housing.
- To **REMOVE** the smaller adjustable jet insert, wear latex or rubber gloves. Turn counterclockwise until you reach the stopping point. Exert more pressure to turn past the stopping point and as the jet 'clicks' pull the insert toward the center of the spa. Gently pull the jet insert from the housing.
- To **CLEAN** the jet insert and housing, use a pressurized hose and spray the inside of the

jet. Soak the jet in a diluted spa cleaning solution, rinse. Wipe the inside of the housing to remove any debris.

- To **REINSTALL** the jet, line up the tab on the backside of the barrel with the groove in the body. Use the palm of your hand to gently tap the jet until it snaps into position.

**NEVER SHUT ALL FULL SIZED
JETS OFF AT ONE TIME!**

AIR CONTROLS

The intensity of the jet action can be controlled by altering the amount of air injected with water through the jets. Your spa has one or more air controls located on the lip of the spa. Each control activates air to specific jets in the spa allowing you to create various combinations and levels of jet action to suit individual preferences. Turn the control counter-clockwise to turn the air off and clockwise to turn air on.

NOTE: Air controls should be closed during heating cycles for maximum energy efficiency.

NOTE: At the start of a filtration cycle, the Optional Air System is activated to purge the lines and ensure complete filtration.

Ensure that at least one air control is always fully open.

ELECTRICAL INFORMATION

**Caution: Risk of electrical shock.
Read and follow all instructions.**

IMPORTANT SAFETY INSTRUCTIONS

All electrical connections to this spa package **MUST** be done by a qualified licensed electrician or certified technician in accordance with National Electrical Code (NEC) and with state/local electrical codes in effect at the time of installation.

NOTE: Prior to performing any service to the spa equipment, turn OFF all primary electrical power at the main circuit breaker or disconnect panel.

To make spa electrical connections, remove the exterior equipment access panel, locate the electrical control box, remove the control box cover and follow the wiring diagram on the inside of the control box cover.

Connections should be made using copper conductors only; DO NOT use aluminum.

Connecting wires, circuit breakers or fuses must all be sized to accommodate the Total Ampere load as specified on the equipment label.

This equipment is designed to operate on 50Hz or 60Hz alternating current only, at 240 volts or 120 volts, as required.

NOTE: All unions must be hand-tight and all slice valves must be locked in the OPEN position before filling or refilling spa!

A clip is provided to help keep the slice valve open. Run spa and check for union water leaks before reinstalling front panel.

FOR EUROPE ONLY

The spa is intended for use only in premises having a service current capacity ≥ 100 A per phase, supplied from a distribution network

having a nominal voltage of 230 V. The user shall determine in consultation with the supply authority, if necessary, that the service current capacity at the interface point is sufficient for the spa.

Equipment complying with IEC 61000-3-11.

GFCI

(Ground-Fault Circuit Interrupter)

A qualified licensed electrician must connect the spa to a circuit protected by a GFCI. This is a requirement by the National Electric Code, article 680.44, and is also in compliance with Underwriter's Laboratories, Inc.

RESIDUAL CURRENT DEVICE

The appliance should be supplied through a residual current device (RCD) or Ground Fault Interrupter (GFCI) with a rated tripping current not exceeding 30mA. Means for disconnection must be incorporated in the fixed wiring in accordance with the wiring rules. Parts containing live voltage, except parts supplied with safety extra-low voltage not exceeding 12V, must be inaccessible to a person in the bath. Earthed appliances must be permanently connected to fixed wiring.

INSTALLATION OPTIONS

Refer to the manufacturer's nameplate located on the kick plate to determine your spa's amperage requirements.

Note: Copper wire is strongly recommended for all electrical connections.

Spas installed for 120 volt operation require a 3-wire, 40, 30, 20 or 15 amp., 120 volt sub-feed in non-metallic pipe to the spa

equipment compartment (line 1, neutral and ground). A green colored terminal (or wire connector marked "G", or "GR", or "Grounding") is provided in the control box. To reduce the risk of electrical shock, connect this terminal or connector to the grounding terminal of your electrical service or supply panel with a continuous green insulated copper wire equivalent to the circuit conductor supplying this equipment, but no smaller than No. 12 AWG. A second pressure wire connector is provided on the surface of the control box for bonding to local ground points. To reduce the risk of electrical shock, this connector should be bonded with a No. 6 AWG copper wire to any metal ladders, water pipes, or any metal within 5 ft. of the spa.

Spas installed for 240 volt, 60 Hz, single phase operation require a 4-wire, 60, 50, 40 or 30 amp., 240 volt sub-feed in non-metallic pipe to the spa equipment compartment (line 1, line 2, neutral and ground). A green colored terminal (or wire connector marked "G", or "GR", or "Grounding") is provided in the control box. To reduce the risk of electrical shock, connect this terminal or connector to the grounding terminal of your electrical service or supply panel with a continuous green insulated copper wire equivalent to the circuit conductor supplying this equipment, but no smaller than No. 12 AWG. A second pressure wire connector is provided on the surface of the control box for bonding to local ground points. To reduce the risk of electrical shock, this connector should be bonded with a No. 6 AWG copper wire to any metal ladders, water pipes, or any metal within 5 feet (1.5m) of the spa.

A pressure wire connector is provided on the exterior surface of the control box inside the spa. This is to permit the connection of a ground bonding wire between this point and any metal equipment, enclosures, reinforced concrete pad, pipe, or conduit within 5 feet (1.5m) of the spa (if needed to comply with local building code requirements). The bonding wire must be at least a #10 AWG solid copper wire.

Bond the spa to all exposed metal equipment or fixtures, handrails, and concrete pad per N.E.C. Article 680 and all local codes.

1. Push the "TEST" button on the GFCI/RCD breaker. The spa should stop operating and the GCFI power indicator will go out.
2. Wait 30 seconds, then push the "RESET" button. Power will be restored to the spa and the GFCI/RCD power indicator will turn on. If the GFCI/RCD fails to operate in this manner, your spa may have an electrical malfunction, and you may be risking electrical shock. Turn off all circuits and do not use the spa until the problem has been corrected by an authorized service agent.

WARNING: Removal of the GFCI/RCD from the spa's power cord will result in an unprotected spa and will void the spa's warranty.

IMPORTANT: Should you ever find the need to move or relocate your spa, it is essential that you understand and apply these installation requirements. Your spa has been carefully engineered to provide maximum safety against electrical shock.

VOLTAGE/AMPERAGE CHART:

240 Volt Installation Units

Electrical Requirements

Requirement

- 240 volt/60 amp, 50 amp, 40 amp, or 30 amp.
- 60 Hz
- Single phase
- 4-wire service (line 1, line 2 neutral and ground)

NOT NORTH AMERICAN

- 240 volt
- 50 Hz
- Single-, two-, or three- phase service
- Refer to wiring diagram or pouch on control system inside cabinet for specific wiring and phase information.

THIS SECTION

**APPLIES TO SPAS
INSTALLED OUTSIDE OF
NORTH AMERICA**

Number	Meaning
1	The heater will only remain running with no more than two pumps on high speed. All pumps will run on high speed when heater is off.
2	The heater will only remain running with Pump 1 on low speed. Only the spa light can operate at the same time without disabling the heater. All pumps will run on high speed when heater is off.

DEDICATED 240V UNITS North America				
MODELS	240V/60A	240V/50A	240V/40A	240V/30A
DM8 (Spa Side)			1	2
DM8 (Swim Side)	1	2		
MX6	1			
MB4	1	2		
ML4	1	2		
RB4	1		2	
RL4	1		2	
RF2	1	2		
982	1			
880	1	2		
881	1	2		
481	1		2	
480	1		2	
472	1		2	
471	1		2	
470	1		2	
460	1		2	
461	1		2	
451			1	2
282	1		2	
281	1		2	
280	1		2	
271	1		2	
270	1		2	
261			1	2
250			1	2
171	1		2	

See previous page for explanation of corresponding numbers.

START UP PROCEDURES

Follow recommendations for site location and electrical connection. 6" (15.5cm) below the top lip of the spa is the level at which the water should be maintained.

1. Fill the spa through the filter hole to 6" (15.5cm) below the top of the spa with tap water. **Never use 'softened' water in your spa.** Softened water can impact the chemical balance of the water and lead to degradation of metal plumbing fittings and possible jet plastic damage.
2. After you have assured that the spa/swim spa is full of water and that all plumbing valves are open, turn power on to unit at circuit breaker or disconnect panel.
3. Open the air controls, located on the top lip, and cycle the jets from high to low. Water should come from the therapy jets. If water flow is not established, turn off jets and see Priming Your Spa (next column).

Important: Do not operate the spa without full water flow.

4. Add chemicals. See Chemical Treatment and Water Maintenance section. Follow Operating Insutructions for your particular model to set heat to the desired temperature. Initially, you may find that the spa requires 12 to 14 hours (18 to 24 hours for swim spas) on 230 Volt installations to reach temperature. Keep your thermal cover on the unit and close the air controls to help the heating process.
5. Verify all drain valves are closed, some are under the spa.

PRIMING YOUR SPA

When filling your spa for the first time or after draining and refilling the spa, you may need to bleed air from the system. Should you experience an air-lock on Pump 1, remove the filter cover, insert a garden hose through each center hole that holds the filter as far as possible without using force. Hold the hose in place and turn on the water. Cycle pump 1 from low to high several times, this forces water into the pump and forces the air out. If this does not work or you experience an air-lock on Pump 2, remove the side panel and locate the pump. With the pump on high speed, slowly loosen the discharge (top) pump union until water starts to trickle out. Once water is trickling out, hand tighten the union (do not over tighten as this could cause the union to crack) and replace the side panel.

Pr - Prime/Purge Pumps

This is Not an Error Message.

The Spa has just been powered up and is in Priming Mode for 4 Minutes. Pumps can be turned ON and OFF to remove any air from the plumbing lines and the Heater. Cycle the pumps on and off to verify good water flow and wait 4 minutes or press any temp related button to exit Priming Mode.

CONTROL PANEL TYPES AND MODELS

in.k500 Control Panel



This easy to use control has been programmed to be “plug and play.” Turn the power on, adjust the desired temperature and the system is ready to go. If there are situations that require additional filtering time, the filter settings can be customized to any special requirements. Simple to use and easy to read, the POWERWORKS® Control System makes controlling the spa effortless.

CONTROL PANEL OPERATION

Please note: All pumps and light have an automatic timeout (shut-off) programmed 30 minutes after the pump or light is activated. Lights have an automatic shut-off after 60 minutes.

Power

Press any key to turn the control panel on. After 30 minutes without activity, it will shut off.

Main Screen

The main screen provides access to your accessories and water temperature. At the bottom of the screen you will see any error or maintenance messages that are present.



Start or Stop Accessories

To start or stop an accessory, press the associated button. Icons will become animated when their accessory is turned on, and inanimate when turned off. Icons on the screen will reflect the speed or state of the devices running on your spa.

When an accessory has more than two states, press the button until it reaches the desired state.



Water Temperature

The temperature shown at the top of the screen (in white) is the actual water temperature. Use the Up and Down keys to set the desired temperature. The set temperature will appear in blue at the bottom. After 3 seconds without any change to the temperature value, the current water temperature will reappear.

When the set temperature is lower than the current water temperature, Cooling to **XX**°F will appear on the bottom of the screen. When the set temperature is higher than the current water temperature, Heating to **XX**°F will appear. Normally there is a brief delay before the heating starts, during which Heating Suspended is indicated on the screen.



Note: a "Cooling" message does not necessarily indicate that your spa is equipped with optional cooling equipment (e.g. heat pump)

Settings

Access the Settings by a press of the **Settings** key from the home page. The following categories will appear on the Settings menu:

- Water Care
- Audio
- Date & Time
- Keypad Settings
- Electrical Configuration
- About



Use the **Up** and **Down** keys to move up or down in the menu. To select an option, press the lit key beside it (**Pump2** key). At any point, a press of the **Settings** key will return to the home page.

Water Care

The water care section will help to select the ideal filtration and heating settings. Choose from *Away*, *Standard*, *Energy Savings*, *Super Energy Savings*, and *Weekender*, depending on your need. Use the Up and Down keys to choose your setting. To select a mode, press the lit key beside it (Pump 2 key) A checkmark will appear on the selected icon to confirm.



Water care modes



Away:

In this mode the spa will always be in economy; the set point will be reduced by 20° F*.



Standard:

The spa will never be in economy mode and will be filtering according to the pack's low level configuration.



Energy Savings:

The spa will be in economy mode during the peak hours of the day and resume normal mode on the weekend*.



Super Energy Savings:

The spa will always be in economy mode during peak hours, every day of the week*.



Weekender:

The spa will be in economy mode from Monday to Friday, and will run normally on the weekend*.

**Filtration will be reduced when the economy mode is active.*

Filtration System

The spa is factory programmed to filter the water. The schedule and duration depend on the water care mode selected, and can be modified as needed (please see the Modifying Schedules for instructions). The filtration cycles occur in two steps: a purge step and a clean step. During the purge step, typically, all pumps are turned on for one minute to purge the spa plumbing. For the remainder of the filtration cycle, pump #1 low speed will operate to perform the clean step.

The filtration cycle can be suspended by pressing any of the pump keys. The filtration cycle will resume after 40 minutes from the last key pressed.

Modifying Schedules

To see and/or modify a Water Care category, use the lit button to the right (Key 1) to open the selected Water Care menu.

Use the arrow keys to choose a schedule to modify. You have several possibilities for the schedule (mon-Fri, weekend, every day, or single days). The schedules will be repeated every week. The time and duration are set in 30 minute increments. Once you have set the schedule, use Key 1 to go back. Ensure that you have selected the desired Water Care option in the main Water Care menu.



Audio

The Audio section in the Settings menu of an in.k500 gives you the option to connect or disconnect your Bluetooth enabled device when using the in.stream2. The audio option will only appear in the menu on spas that are equipped with the optional Bluetooth Music System. The in.stream 2 is automatically detected at power-up.



Date & Time

Here you can adjust the time format, change the year, date, and time. Use the arrows to choose the setting that you want to adjust and select it by pressing the Light key.

Use the arrow buttons to change the parameters, and the Light key to move between parameters. Key 1 will take you back to the main Setting menu.



Keypad Settings

In this section, you can change the temperature unit, language, display orientation, and keypad security. You can lock the keypad by selecting one of 3 security levels: Unlock, Partial, or Full. The partial level locks the set point adjustment and many options in the settings menu. The Full level locks all keypad functions. To unlock the keypad (either Partial or Full), press and hold the Light key for 5 seconds.



Electrical Configuration

Please do not make any changes in this section. Changes made in this section may cause components to become inoperable.



Wi-Fi

This menu allows you to view an optional in.touch2 module's connection to a Wi-Fi network.

To review its connection to a wireless network, use the Up/Down keys to go to the WiFi option in the Settings menu and Light key to select it.



Use the Up/Down keys to move through the list and use the Light key to select your network.

- Use Key 2 to move the cursor forward
- Use Key 1 to backspace
- Use the Light key to confirm



About

This selection displays the software information of the control panel and control pack.



FEATURE OPERATIONS

JET SELECTOR VALVES (DIVERTER VALVES)

Your spa may be equipped with a jet selector valve (diverter valve). This valve can be used to divert jet power from one area in the spa to another area. This valve is fully adjustable and can be used to suit the user's desired effect. The valve may be slightly harder to turn when the jet pump is on high speed. This is normal due to high rate of water flow and pressure present in the valve.



AIR CONTROL VALVES

Your spa may be equipped with air controls. The air control is an on/off valve that allows air to be introduced into a specific jet configuration resulting in a more vigorous jet action. This valve looks similar to the jet selector valve (diverter valve), however it is smaller in size, and it has the word AIR on the handle. Turn the valve handle clockwise to turn the air on, and counterclockwise to turn the air off. Opening the valve increases jet pressure and closing the valve decreases the jet pressure.



WATER FEATURE/WATERFALL CONTROL VALVE

Your spa may be equipped with a waterfall or water feature(s) that is controlled by a water feature/waterfall control valve. This valve looks identical to the air control valve but without the word AIR on the handle. Turn the valve handle clockwise to turn the water feature(s) on, and counterclockwise to turn the water feature(s) off.



in.stream2 AUDIO SYSTEM

Your spa may be equipped with a stereo system. Please refer to the separate Audio Set-Up Guide for the operation of the stereo system.

IN.TOUCH2 SYSTEM

Your spa may be equipped with the in.touch WiFi system. This system allows the use of an Apple™ or Android™ device to control the spa. Please continue to the next page for basic set-up instructions.

in.touch2 BASIC SET-UP INSTRUCTIONS

Simplest of Setups

in.touch 2 eliminates all the complexities of connecting your spa to the Internet and transforms your smartphone or tablet into your ultimate Wi-Fi spa remote control. in.touch 2 comes with a state-of-the-art app and 2 prepared radio frequency transmitters, one being part of your spa system and the second one being connected to your Internet router. Both RF transmitters are prelinked to one another, enabling an immediate and perfect communication between you and your spa.

Strong & Long Range Communication Signal

Through their proprietary RF technology, in.touch 2 transceivers emit a strong, stable and long range signal between your spa and your router (about 3 times longer than regular Wi-Fi signal). No need for repeaters or boosters: your spa will always remain within reach in typical backyard settings.

State-of-the-art App with Push Notifications

in.touch 2 streamlined application makes it very easy to control and program all the functions and features of your spa from your smartphone or your tablet. Even when you're away from home, you get full control of your water care settings, filtration cycles, water temperature, economy modes and a lot more. Push notifications will always keep you informed on the status of your spa, even when your app is not open.



Each in.touch2 module has a status LED that can be used for troubleshooting purposes. The LED is located on the top of both enclosures.



EN Module (home)

Pairing mode	Yellow (Blinking)
Router not detected	Red
Router detected	Green
in.touch 2 server detected Module is fully functional	Blue

CO Module (spa)

Pairing mode	Yellow (Blinking)
Spa controller not detected	Red
in.touch 2 server detected Module is fully functional	Blue

* When the LED status is blinking (blue, green or red) this indicates that the communication between the EN module and the CO module is not established.

Download Application

The in.touch2 app allows you to control your spa using your home network or an Internet connection anywhere in the world. The in.touch2 app can be found in the App Store for iOS devices - search for <in.touch 2> then click to install.



Using the App

Using the app

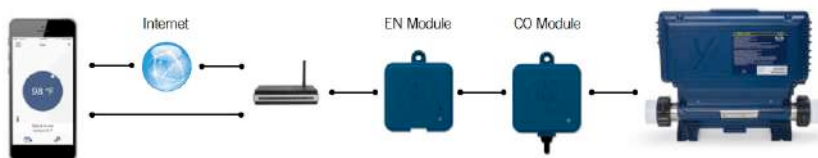

On Your Home Network

It is possible to access your spa with the in.touch 2 app through your home network. To be able to see your in.touch 2 in the application you need to connect your device to the same router (Wi-Fi network) than the one used to connect your in.touch 2-EN module.

Go to the Wi-Fi settings section of your mobile device and choose the same network that your spa is connected to (i.e. Home). Once you've selected it, wait until your device confirms the connection.

On the Internet

The in.touch 2 allows you to use the Internet to control your spa from anywhere in the world. In order for them to communicate, both the in.touch 2 module and your device must be connected to a network that allows access to the Internet.

Once your in.touch 2-EN module is connected to the Internet (the LED status is blue), you can use your in.touch 2 app any time your device is also connected to the Internet (wireless or cellular network), even if you are away from home.

To have access to your spa away from home, you will need to have previously linked your mobile device to your spa on your home network.

Setup your Wi-Fi on your iOS Device

Before using your application, go to the Wi-Fi section of your device's settings.

Make sure you are connected to your home network. This needs to be the same Wi-Fi provided by the router to which you connected your in.touch 2-EN module.



Start the in.touch 2 Application

Find the icon for the in.touch 2 application, then tap on it to open it.



The first time you use the application a message will ask you: "in.touch 2" Would like to send you notifications. If you choose Allow, the application will send you notifications about the status of your spa. If you choose Don't Allow, the application will not send you notifications.

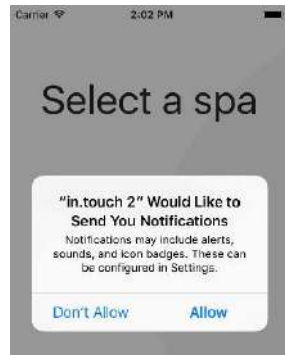

If you change your mind later concerning notifications, you may add or remove notifications for the in.touch 2 application. Go in your settings menu in your iOS device and choose in.touch 2. Select the notifications menu, you can turn notifications on or off from this page.

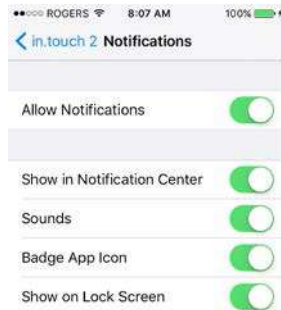







Select a Spa

This page displays all the spas detected by your application.

To detect your spa, you need to connect your mobile device to the same network to which you connected your in.touch 2-EN module.

Once you have done a connection with the spa its name will be saved on this page to allow you to connect to this spa from anywhere.

The RF signal strength (communication between the two in.touch 2 modules) is illustrated on the Select a spa page. There are 6 possible states:

-  • Signal superior to 80%
-  • Signal between 80% and 51%
-  • Signal between 50% and 31%
-  • Signal below 30%
-  • The in.touch 2 CO (spa) module is not available
-  • The in.touch 2 EN (home) module is not available

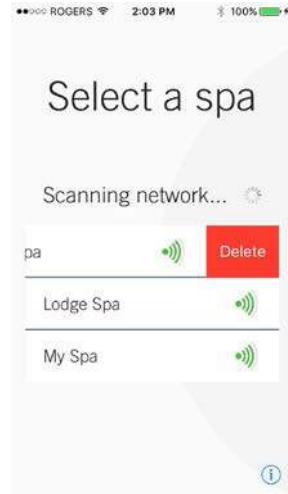

Note: If you are currently connected on the same local network as your spa and try to delete it, this one will reappear as soon as the menu refreshes.

To delete a spa from this list, slide the spa name to the left and tap on Delete.







Home Page

The main screen gives you access to your accessories, water temperature, water care and settings.



Spa State

This page displays all the active states of your spa. Below is a quick description of each state you may encounter on your spa. Each state is associated to a priority and color that determines the color of the widget on the home page.

-  Indicates that there is an error on your spa.
-  Indicates that there is presently an active user demand on your spa (ie. pump, blower or light is on).
-  Indicates that your spa is now heating to your set point.
-  Indicates that your spa is now in a filtering cycle.
-  Indicates that your spa is now in economy mode.
-  Indicates that your spa is running normally (there is no user demand, heating, no filtration or economy active).



The widget on the home page displays a single color at a time. The color displayed is decided by priority of state. The established priority is as listed above.

Settings

In the Settings page you can access the following:

- Wi-Fi
- in.touch network
- Tips
- Temperature units
- About

To select an item, tap on the arrow next to it. It will open the selected menu.

Wi-Fi

In the Settings menu the Wi-Fi line indicated to which network your mobile device is actually connected.

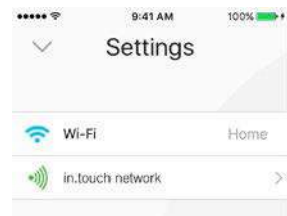

in.touch2 network

The in.touch2 network menu allows you to have access to information concerning the RF connection parameters between the in.touch 2- EN and in.touch 2-CO modules.

This menu gives you access to:

- Channel
- Signal strength
- Reset channel (resets channel to default)

To change channels, press on the Channel line.



Change Channel

The Change channel page allows you to change the channel used by the two in.touch 2 modules. In some cases it is possible this will help you to have a stronger signal.



WATER BALANCE

WATER CHEMISTRY

Maintaining proper water chemistry is imperative to maintaining safe water and preventing possible damage to your spa and spa components.

START-UP PROCEDURES

1. Fill spa to correct level (approximately 5" below the top of spa). Keep spa cover open while treating water.
2. When utilizing the Aqua Klean® filter bag, you may add stain and scale control, or a similar sequestering agent, such as Metal Gone.
3. Test and adjust total alkalinity – run pump for ½ hour.
4. Test and adjust pH – run pump for ½ hour.
5. If sanitizing with bromine, add sodium bromide with jets running (*see Bromine section*).
 - a. Fill and set bromine floater or adjustable bromine feeder and place in the spa water.
 - b. Shock water with potassium peroxymonosulfate (such as "Renew") with jets running.
6. If sanitizing with chlorine, use only a granular "Dichlor" compound (*see Chlorine section*).
 - a. Fill and set chlorine floater or chlorine feeder and place in the spa water.
 - b. Shock water with potassium peroxymonosulfate (such as "Renew") with jets running.
7. Run pump for ½ hour.
8. Wait ½ hour after introducing the last water treatment (e.g. Metal Gone, Renew, Chlorine) before closing spa cover.

WATER QUALITY

Your spa is equipped with a specially designed Aqua Klean® filter system. Filtering the water helps maintain water cleanliness and clarity. While the filter traps most solid materials, it is still necessary to add a sanitizer such as bromine or chlorine to the water in order to control bacteria, algae, and to oxidize any organic materials in the water.

We recommend that you purchase your chemicals from your authorized American Whirlpool dealer. The dealer can also advise you on alternative methods for water sanitation. **Use of incorrect chemicals can be dangerous and may void the warranty on your spa.**

pH CONTROL

All water has a pH value determined by a scale of 0-14, which is a measure of the acid to alkaline relationship. While a pH reading of 7.0 is considered neutral, a lower reading is considered acidic and a higher reading is alkaline. The proper pH for spa water is between 7.2-7.6. High pH (above 7.8) can reduce sanitizer efficiency, cloud the water, promote scale formation on spa surface and equipment and interfere with filter operations. When pH is too high, add a pH decreaser. Low pH (below 7.2) is equally damaging and can cause equipment corrosion, water that is irritating, and rapid sanitizer dissipation. Add pH increaser to adjust the level. Follow the chemical manufacturer's directions and procedures when adding chemicals to spa water.

NOTE: Always add pH adjuster with jets operating and circulate all chemicals for at least 30 minutes. Remember that good pH control and sanitation are absolutely essential for proper spa water treatment.

TOTAL ALKALINITY

Total alkalinity is the amount of carbonate, bicarbonate, and hydroxyl ions in the water. Total alkalinity affects and buffers the pH of the water. With high total alkalinity (above 160), pH resists adjustment. With low total alkalinity (below 130), pH is unstable and difficult to keep in the ideal range. Proper total alkalinity levels allow other spa chemicals to work effectively.

WATER TREATMENT

SANITIZERS

The importance of maintaining an adequate level of sanitizer in your spa cannot be overemphasized. Warm water presents a fertile environment for the growth of bacteria and viruses. This growth is prevented when adequate sanitizer levels are continuously maintained.

WARNING – Sanitizers such as tri-chlor (tablets or sticks), calcium hypochlorite, sodium hypochlorite, and any chemical that dissolves on or remains un-dissolved in contact with the spa surface will damage your spa surface and will void the warranty completely.

BROMINE

Bromine is the most common sanitizer used in spas. Adjust the floater to maintain a total bromine level of 3.0-5.0 ppm. If the reading is below the minimum, raise the level before using the spa. If the reading is above 5.0 ppm, allow ppm to drop to the proper range before using the spa. Brominating tablets are a convenient and effective source of bromine for your spa. Do not drop bromine tablets directly into the water as this may damage the spa surface. A chemical “floater” safely and properly dispenses the tablets into the spa water. When used properly, brominating tablets will keep your water clean, clear, and odor-free. To ensure maximum effectiveness, add ½ oz. of sodium bromide per 100 gallons of water every time you fill your spa. This will establish a bromide reserve.

CHLORINE

Chlorine is a water sanitizer also, however it is more sensitive to pH than bromine. To be effective, you must have a pH range of 7.2-7.6. Any reading outside this range will greatly reduce chlorine effectiveness.

Use a chlorine test kit or test strip to maintain a reading of 2.0-3.0 ppm of free chlorine. If the reading is below the minimum, raise the level before using the spa. If the reading is above 5.0 ppm, allow ppm to drop to the proper range before using the spa. Read the instructions on your chlorine container carefully, or consult your local American Whirlpool dealer if you are having difficulty adjusting your chlorine level.

The best chlorine for your spa is a granular “Dichlor” compound. It dissolves quickly in moving water and has a nearly neutral pH. Add chlorine while jets are running and let the jets run for ½ hour. Generally, heavily contaminated water can be disinfected using large chlorine doses, in the range of 8-10 ppm, but a more practical method is to drain the spa and refill it with fresh water.

The effectiveness of chlorine is decreased when the cover is left off the water for two reasons: (1) sunlight decays chlorine rapidly, and (2) organic debris is blown into the spa and taxes the effectiveness of the chlorine. In addition, the higher the water temperature, the faster chlorine will decay.

NOTE: Two or more individuals in a spa may reduce the level of sanitizer rapidly.

SUPER CHLORINATION

Super chlorination quickly oxidizes the spa water to burn out wastes such as perspiration, hairspray, lotions, etc. that cannot be removed by the spa filter. This waste build-up reduces the power of the sanitizer, making the water dull and irritating to the eyes and skin. It may also produce an odor. When this occurs, the free chlorines have become chloramines which are much less effective as a sanitizer. This can be eliminated by super chlorination as needed. An application of 5 times the normal chlorine dosage will act as an adequate treatment.

SHOCK TREATMENTS (POTASSIUM PEROXYMONOSULFATE)

Even with regular sanitization, shock treatment may be necessary on occasion. Shock is recommended over super chlorination because it does not add additional sanitizer to the water. It is also effective in oxidizing wastes and will reduce chloramines or bromamines. Follow the manufacturer's instructions listed on the label.

OZONE

Your spa maybe equipped with an ozone generator. American Whirlpool requires that only their ozone generator be used on spas due to the design of the mixing chamber system. Ozone related failures due to use of other manufacturer's ozone generators will not be covered under warranty. Ozone delivery occurs when the circulation pump is running.

UV

Equipping your spa with an Ozone system that includes the Ozonator or UV Sanitizer is a smart decision. The use of ozone in conjunction with spa sanitizing and water balancing chemicals helps to provide you with a cleaner, healthier spa, reduces chemical usage, and protects your skin from chemically induced irritation.

WATER TESTING

It is recommended that you test your spa water regularly with an accurate test kit or test strip. These are available from your local authorized American Whirlpool dealer. Be sure to follow the chemical manufacturer's instructions for chemical use.

STAIN AND SCALE INHIBITOR

Staining and scaling may be a common problem in spas. Because the water is hot, scale may be deposited more quickly. The circulation of water can cause the erosion of metals from spa equipment, which can stain interior surfaces. A weekly dose of a stain and scale fighter will help control these problems.

A sequestering agent, such as Metal Gone, can be added to the spa water when filling a spa (for the first time or when draining and refilling). This will help eliminate metals in your water and increases the life of your spa equipment.

FOAM INHIBITOR

Soap residue from a user's body, hair, and swimsuit combined with rapid circulation of spa water may cause foaming in your spa. Foam inhibitors will suppress foam, but cannot remove soap from the water. When foaming occurs, a shock treatment can oxidize the soap in your water and help prevent this condition. If foam remains a problem, change the water. Consult the directions on the foam inhibitor container for usage amount. When adding chemicals to your spa water, add to the center of the spa with the pump operating. Never add chemicals directly into the skimmer. Make sure the water is heated. Never add chemicals to cold water, as this will affect the chemical reaction.

Store all chemicals in a cool dry location and in such a manner to prevent contact by children or pets.

You should consult your local authorized American Whirlpool dealer prior to any chemical use.

KEEPING YOUR WATER CLEAN AND SAFE

Monday		Friday	
Test:	Bromine/Chlorine pH Total Alkalinity	Test:	Bromine/Chlorine pH Total Alkalinity
Adjust:	Follow steps 1 - 4	Adjust:	Follow steps 1 - 4
Add:	Stain & Scale control	Add:	Stain & Scale control

Step 1: Adjust total alkalinity – ideal range is between 130-160. Test water, follow directions on manufacturer’s label, and add the required amount of spa chemicals with the jets on. Wait 30 minutes before performing additional tests.

Step 2: Adjust pH – ideal range is between 7.2-7.6. Test water, follow directions on manufacturer’s label, and add the required amount of spa chemicals with the jets on.

Step 3: Adjust bromine/chlorine – ideal range is between 2-3 ppm chlorine and 3-5 ppm bromine (4-6 ppm for heavy spa usage). Fill bromine floater or adjustable feeder and shock spa as necessary.

Step 4: Stain and scale control – once a week add the required amount of spa chemicals with jets on.

NOTE: The chemical chart above is a simple schedule for moderate spa use. Depending on the usage, chemical balancing may be required more often.

SPA CARE

FILTER CLEANING

Always make sure the spa is off before removing and cleaning the filter cartridges. We recommend the cartridges be cleaned every two weeks to avoid a decrease in jet performance. On initial start-up, the filters should be cleaned every other day for the first two weeks of operation.

To clean the filter bags, place them into the washing machine. Use ¼ cup of bleach, wash with warm water in gentle cycle. Do not machine dry.

CARE FOR SPA SURFACE

American Whirlpool spas have a very high quality finish. Stains and dirt will generally not adhere to the surface. After draining the spa, wipe the surface with a soft damp cloth (or sponge) using household soap or liquid detergent. Stubborn dirt and stains maybe removed by using Spic & Span adequately dissolved in water. Be sure to rinse detergent well as this will cause suds when refilling the spa.

CARE FOR SPA PILLOWS

Due to the nature of a spa's environment, spa pillows are exposed to chemicals, which in turn can affect the pillow's useful life. To be extra careful, we encourage you to always remove the spa pillows when adding chemical treatments to your spa's water. The spa pillows can then be re-installed to the spa when the chemical level is at the recommended parts per million (PPM). For most spas, this is between 3-5 PPM.

Furthermore, spa pillows should be cleaned regularly. To do this, remove the pillows from your spa, and then wipe the pillows with a soft damp cloth using mild dish washing soap and warm water. Rinse off the excess soapy water, and then simply re-install the pillows onto your spa.

CARE OF SPA CABINET

Your spa cabinet requires little or no maintenance of any kind. To clean, simply wipe cabinet with a clean towel and mild detergent soap solution.

CAUTION – Do not use any cleaning products containing abrasives or solvents. Do not stain, paint or otherwise cover the cabinet with any substance since these can and will damage the ultraviolet clear coat used on the surface of the spa skirt and void your warranty.

CARE FOR WEATHERSHIELD SPA COVER

Your WeatherShield spa cover is an extremely durable foam insulated product. When your spa is not in use, it is highly recommended that the cover tie downs always be utilized to discourage unsupervised children from entering the spa and to minimize heat loss. See your WeatherShield spa cover Owner's Manual for proper installation instructions.

Spa covers should be cleaned regularly. To clean the cover, simply wipe the cover using a clean towel with a mild detergent or soap solution. Do not use any cleaning products containing abrasives or solvents since these could damage the cover surface and void your warranty. You may apply fabric protectant on the spa cover. Use one specified by your spa dealer only. This will provide a protective coating for your spa cover. Follow the instructions on the label of the protectant product. Lastly, consult your American Whirlpool Authorized Dealer for further questions regarding your spa cover.

DRAINING THE SPA

1. Turn power off to spa.
2. Attach a hose to the external drain located on the front panel or corner of the bottom pan. Open the valve and allow the water to drain away from the spa.
3. Clean the spa surface (see care of spa surface in this section).
4. Refill spa, and follow initial start-up procedures to reheat the spa.

SPECIAL COLD WEATHER INSTRUCTIONS (WINTERIZING)

Winter can be one of the most enjoyable times of the year to enjoy your spa. As it is difficult to get water out of the plumbing lines, WE DO NOT RECOMMEND DRAINING YOUR SPA FOR THE WINTER. However, if you decide not to use your spa during the winter, we recommend you winterize as follows:

1. If you drain your spa, turn off the main power to the spa. Drain as completely as possible. You may want to use a wet-vacuum or high-pressure blower to evacuate as much water as possible.
2. When the spa is completely empty, leave the hose bib open and open the pump drain plug located on the bottom side of the front end of the pump. Loosen all pump unions and fittings to allow air and water to expand freely within the system. This should help prevent water from freezing and damaging pipes and fittings. The idea is to try to eliminate water from any sealed areas in

Should you have a heavy snowfall during the winter months, you may want to build a protective cover cap for the spa cover. This may be done with a 1/2" or 3/4" piece of plywood and a few 2" x 4" cross members.

Although your spa is equipped with an automatic freeze protection, a power outage can cause your spa equipment system to freeze quickly. During freezing conditions, check your spa frequently to ensure proper operation. Be sure to check your spa after any power failure to ensure the spa is operational.

For additional information on winterizing your spa, contact your local American Whirlpool dealer.

THERMAL CREEP

Your spa is manufactured with energy-efficient components and systems that capture heat generated by the equipment, then transfers that heat back to the spa water. In warmer weather or in situations with extended run times, Thermal Creep may occur. Thermal Creep is a condition whereby the actual water temperature is higher than the set temperature. To manage "Thermal Creep" you may:

1. Vent your cover: Newer covers have removable center seal padding. To remove this padding, open the Velcro on one side of the vinyl pouch and slide the white padding out. If your spa does not have removable center seal padding, you may instead place a folded cloth about 3/4" (2cm) thick under all four corners of the cover before you lock it down. Opening the cover at night will also quickly cool the water down if desired.
2. Open all air controls.
3. Set your filtration cycles to run during the cooler times of the day or at night.
4. Reduce the length of your filter cycles.
5. Visit your local dealer for additional guidance.

Thermal Creep only occurs in well-insulated hot tubs. It is not an indication that something is wrong with your spa or the equipment.

WARRANTY SERVICE INFORMATION

Your American Whirlpool warranty gives you specific coverage. Be sure you read your warranty carefully and return your completed warranty card to your American Whirlpool dealer upon completion of installation. You may also register your new spa's warranty online at: <https://americanwhirlpool.com>

PLEASE NOTE: The warranty does not cover problems resulting from misuse, abuse, or neglect, and it does not cover problems caused by improper installation or perceived problems caused by failure to read the spa owner's manual.

TROUBLESHOOTING

HEATING SYSTEM

Symptom	Problem	Corrective Action
Spa water cold / spa not heating	<ol style="list-style-type: none"> 1. Temperature setting is not at user select. Power reset caused default setting 2. Spa in economy mode 3. Dirty filters 4. Air lock 5. Jets closed obstructing flow 6. Pump gate valve closed 7. Equipment malfunction 	<ol style="list-style-type: none"> 1. Increase temperature 2. Reset to standard mode. 3. Clean filters 4. Prime pump (see page 10) 5. Open jets 6. Open gate valve 7. Call for service
Spa water too warm / spa heating above set point	<ol style="list-style-type: none"> 1. Temperature setting too high 2. Too much filtration 3. Thermal Creep 4. Dirty filters 5. Overheat or high limit occurred 6. Equipment malfunction 	<ol style="list-style-type: none"> 1. Decrease temperature 2. Reduce the number of filter cycles and/or the filter cycle duration 3. Refer to Thermal Creep Section (p. 48) 4. Clean filters 5. Call for service 6. Call for service
Spa temperature erratic	<ol style="list-style-type: none"> 1. Water level low 2. Spa in economy mode 3. Dirty filters 4. Jets closed obstructing flow 5. Pump gate valve closed 6. Equipment malfunction 	<ol style="list-style-type: none"> 1. Fill with water to 5" (13cm) below the top of spa 2. Reset to standard mode 3. Clean filters 4. Open jets 5. Open gate valve 6. Call for service

WATER SYSTEM

Symptom	Problem	Corrective Action
Pulsating jets	<ol style="list-style-type: none"> 1. Water level low 2. Dirty filters 3. Filter intake / pump intake restricted 4. Pump gate valve closed 5. Equipment malfunction 	<ol style="list-style-type: none"> 1. Fill with water to 5" (13cm) below the top of spa 2. Clean filters 3. Remove obstruction 4. Open gate valve 5. Call for service
No jet action or action is poor	<ol style="list-style-type: none"> 1. Jets are turned off 2. Diverter valve turned 3. Water level low 4. Dirty filters 5. Pump gate valve closed 6. Air lock 	<ol style="list-style-type: none"> 1. Turn jets on by turning jet face 2. Turn the diverter valve clockwise or counterclockwise 3. Fill with water to 5" (13cm) below the top of spa 4. Clean filters 5. Open gate valve 6. Prime pump (see page 26)

ELECTRICAL SYSTEM

Symptom	Problem	Corrective Action
Spa will not turn on in any mode	<ol style="list-style-type: none"> 1. No power 2. Equipment malfunction 	<ol style="list-style-type: none"> 1. Check circuit breaker and/or GFCI 2. Call for service
Spa turns on by itself	<ol style="list-style-type: none"> 1. Normal automatic daily filtration cycle 2. Spa required heat to maintain temperature 3. Freeze protection engaged 4. Equipment malfunction 	<ol style="list-style-type: none"> 1. No action required 2. No action required 3. No action required 4. Call for service
Light is out	<ol style="list-style-type: none"> 1. Automatic time out has shut off light. 2. Burned out light bulb 	<ol style="list-style-type: none"> 1. Press Light key again to start another cycle. 2. Replace light bulb
Pump shuts down unexpectedly while in use	<ol style="list-style-type: none"> 1. Automatic timeout has shut pump off 2. Motor overheated and protective device has shut down pump 	<ol style="list-style-type: none"> 1. Press Jets keys again to start another cycle 2. Allow pump to cool. If the pump does not restart when Jets key is pressed, call for service

ERROR MESSAGES

Message	Corrective Action
Hardware error was detected (Thermal fuse)	Reset power to spa. Check for operations of all pumps and accessories. If error code remains, call for service.
High Limit circuit has tripped!	DO NOT ENTER WATER. Add cold water to spa and let the heater cool down, reset power to spa.
No Flow condition; or No Flow condition for more than 2 hours	Reset power to spa. Make sure that the pump associated to the heater is running. Check and clean filters and reset the power to see if the error message goes away. Air locked, prime the pump (see page 22).
Spa temperature is too high	Remove spa cover. Add cold water.
Temp probes or detection circuit are defective	Reset power to spa, if error code remains, call for service.
Elevated internal temperature	Turn off power to the spa to allow the equipment compartment to cool. If error message occurs again, call for service.
Input voltage issue	Call a certified electrician to verify power line quality.

ERROR CODES

Error Code	Description	Corrective Action
Hr	A hardware error was detected in the control pack.	Reset power to spa. Check for operations of all pumps and accessories. If error code remains, call for service.
HL	The high limit circuit has tripped.	DO NOT ENTER WATER. Add cold water to spa and let the heater cool down, reset power to spa.
FLO	Occurs when no flow is detected at the heater.	Reset power to spa. Make sure that the pump associated with the heater is running. Check and clean filters and reset the power to see if error message goes away. Air locked, prime the pump (see page 22). RUNNING THE SPA WITHOUT FILTERS IS FOR TESTING PURPOSES ONLY, NEVER USE SPA WITHOUT FILTERS.
OH	Water temperature is above 108°F (42°C). DO NOT ENTER THE SPA.	Remove the spa cover. Add cold water.
Prr	Temperature probe is defective	Reset power to spa, If error code remains, call for service.
AOH	Temperature conditions inside the equipment area are above 194°F	Turn off power to the spa to allow equipment compartment to cool. If error message occurs again, call for service.

SAFETY SIGN

The safety sign enclosed with your Owner's Manual should be permanently installed where visible to all users of the spa. This sign is adhesive backed and includes four screws for mounting the sign on rough surfaces. It is very important that you, as a spa owner, review the important safety instructions and warnings before you operate your spa. It is equally important that you instruct all users, even occasional ones, as to the warnings associated with spa use.

You may obtain additional signs by contacting :

USA: MAAX Spas Industries Corp..
 Customer Service
 25605 South Arizona Avenue
 Chandler, Arizona 85248
 <https://maaxspas.com>

LIMITED WARRANTY SUMMARY

Please refer to the Warranty Card included with your product for complete warranty information. In order to receive prompt warranty service, you must return your warranty card, completed with model and serial number, to your dealer immediately upon completion of the spa installation. MAAX Spas Industries Corp. provides a limited warranty to our customers. It applies to the spa structure, surface, plumbing, pumps, heater, blower, and controls. The limited warranty does not cover damage resulting from improper maintenance, improper installation, misuse, abuse, accident, fire, normal wear and tear, or improper water maintenance. Unauthorized modifications of the spa may void the warranty. Replacement cost associated with transportation, removal and reinstallation are the sole responsibility of the spa owner. MAAX Spas Industries Corp., reserves the right to make changes in design or material of its products at any time without incurring liability. This limited warranty applies to the first retail purchaser and terminates upon any transfer of ownership.

COPYRIGHTS AND TRADEMARKS

©Copyright 2022 MAAX Spas Industries Corp.. All rights reserved. No parts of this publication may be reproduced, stored in a retrieval system, or transmitted, in any form or by any means (electronic, mechanical, photocopying, recording or otherwise), without prior written permission.

Disclaimer:

The information in this manual is accurate to the best of MAAX Spas Industries Corp.'s knowledge. However, MAAX Spas Industries Corp. assumes no responsibility for errors or omissions. Nor is any liability assumed for damages resulting from use of the information contained herein. Specifications subject to change without notice. Spas shown at variable percentage of actual size.

Congratulations on your purchase of a MAAX® Spas product. Your Owner's Manual provides installation, operation and maintenance instructions.

Please review it and keep it for future references.

**Save These Instructions
Owner's Record Information**

Date Purchases : _____

Purchased From : _____

Phone Number : _____

Installed By : _____

Serial Number : _____ Model : _____

NOTES

ENGLISH

IMPORTANT SAFETY WARNINGS

SAVE THESE INSTRUCTIONS

NOTE: When installing and using this equipment, basic safety precautions should always be taken to reduce the risk of electrical shock, to ensure safe usage, and to safeguard the user's health. Failure to follow instructions and warnings contained in this Owner's Manual, Installation Guide and on the spa/swim spa itself may result in severe personal injury, including death, as well as property damage.

WARNING:
Children should not use spas or hot tubs without adult supervision.

WARNING:
Do not use spas or hot tubs unless all suction guards are installed to prevent body and hair entrapment.

WARNING:
Pregnant, or possibly pregnant, women should consult a physician before using a spa or hot tub.

WARNING:
People with infectious diseases should not use a spa or hot tub.

WARNING:
To avoid injury, exercise care when entering or exiting the spa or hot tub.

WARNING:
Do not use drugs or alcohol before or during the use of a spa or hot tub to avoid unconsciousness and possible drowning.

WARNING:
People using medications and/or having an adverse medical history should consult a physician before using a spa or hot tub.

WARNING:
Water temperature in excess of 100°F (38°C) may be injurious to your health.

WARNING:
Before entering the spa or hot tub, measure the water temperature with an accurate thermometer.

WARNING:
Do not use a spa or hot tub immediately following strenuous exercise.

WARNING:
Prolonged immersion in a spa or hot tub may be injurious to your health.

WARNING:
Maintain water chemistry in accordance with manufacturer's instruction.

WARNING:
Do not permit electric appliances (such as a light, telephone, radio or television) within 5 feet (1.5m) of the spa or hot tub.

WARNING:
The use of alcohol or drugs can greatly increase the risk of fatal hyperthermia in hot tubs and spas.

TABLE OF CONTENTS

IMPORTANT SAFETY WARNINGS	1
TABLE OF CONTENTS	2
IMPORTANT SAFETY INSTRUCTIONS	3
DOS AND DON'TS OF SPA CARE.....	5
Hyperthermia	5
SPA INSTALLATION	6
European Spas	6
SPA Site and Positioning	6
Outdoor Installation	6
Indoor Installation.....	6
Thermal Creep	7
SPA SYSTEM COMPONENTS	8
SPA COMPONENTS	9
JETS AND AIR CONTROLS	10
Jets.....	10
Cleaning or Replacing Jets.....	10
Cleaning Jets.....	10
Air Controls.....	11
ELECTRICAL INFORMATION	12
Important Safety Instructions.....	12
GFCI	12
Residual Current Device.....	12
Installation Options	12
VOLTAGE/AMPERAGE CHART:.....	15
START UP PROCEDURES	18
Priming Your Spa	18
in.k500 Gecko Control Panel	19
Main Screen.....	19
Start or Stop Accessories	20
Water Temperature	20
Settings	20
Water Care.....	21
Water Care Modes	21
Filtration System	21
Modifying Schedules	22
Audio	22
Date & Time	22
Keypad Settings.....	22
Electrical Configurations.....	23
Wi-Fi.....	23
About.....	23
FEATURE OPERATIONS	23
Jet Selector Valves (Divertor Valves).....	24
Air Control Valves	24
Water Feature/Waterfall Control Valve	24
in.stream2 Audio System.....	24
in.touch 2 Wi-Fi System	25
Water Balance	32
Water Chemistry	32
Start Up Procedures.....	32
Water Quality	32
pH Control.....	33
Total Alkalinity.....	33
Water Treatment	34
Sanitizer	34
Ozone	35
UV.....	35
Water Testing	36
SPA CARE	38
Filter Maintenance	38
Spa Surface Care	38
Spa Pillow Care	38
Spa Cabinet Care	38
Spa Cover Care	39
Draining the Spa	39
Winterizing Your Spa	39
TROUBLESHOOTING	41
Heating System	41
Water System	42
Electrical System.....	42
Error Messags & Codes	43
SAFETY SIGN	45
LIMITED WARRANTY SUMMARY	45
COPYRIGHTS AND TRADEMARKS	46
NOTES	47

IMPORTANT SAFETY INSTRUCTIONS

READ AND FOLLOW ALL INSTRUCTIONS

1. **WARNING** - To reduce the risk of injury, do not allow children to use spa unless they are closely supervised at all times.
2. A wire connector is provided on this unit to connect a minimum 6 AWG (5.15 mm²) solid copper conductor between this unit and any metal equipment, metal enclosures of electrical equipment, metal water pipe or conduit within 5 feet (1.5m) of the unit.
3. (For cord-connected/convertible units)
DANGER - Risk of injury.
 - a. Replace damaged cord immediately.
 - b. Do not bury cord.
 - c. Connect to a grounded, grounding type receptacle only.
4. **DANGER** - Risk of Accidental Drowning. Extreme caution must be exercised to prevent unauthorized access by children. To avoid accidents, ensure that children cannot use this spa unless they are supervised at all times.
5. **DANGER** - Risk of injury. The suction fittings in this spa are sized to match the specific water flow created by the pump. If you must replace the suction fittings or the pump, be sure the flow rates are compatible. Never operate spa if the suction fittings are broken or missing. Never replace a suction fitting with one rated less than the flow rate marked on the original suction fitting.
6. **DANGER** - Risk of Electric Shock. Install at least 5 feet (1.5m) from all metal surfaces. As an alternative, a spa may be installed within 5 feet (1.5m) of metal surfaces if each metal surface is permanently connected by a minimum 6 AWG (5.15 mm²) solid copper conductor to the wire connector on the terminal box that is provided for this purpose.
7. **DANGER** - Risk of Electric Shock. Do not permit any electric appliance (such as a light, telephone, radio or television) within 5 feet (1.5m) of the spa.
8. **WARNING** - To reduce the risk of injury:
 - a. The water in a spa should never exceed 104°F (40°C).. Temperatures between 100°F (38°C) and 104°F (40°C) are considered safe for a healthy adult. Lower temperatures are recommended for young children and when spa use exceeds 10 minutes.
 - b. Since excessive water temperatures have a high potential for causing fetal damage during the early months of pregnancy, pregnant or possibly pregnant women should limit spa water temperatures to 100°F (38°C).
 - c. Before entering spa, measure the water temperature as water temperature regulating devices vary.
 - d. The use of alcohol, drugs, or medication before or during spa use may lead to unconsciousness with the possibility of drowning.
 - e. Obese persons and persons with a history of heart disease, low or high blood pressure, circulatory system problems, or diabetes should consult a physician before using a spa.

f. Persons using medication should consult a physician before using a spa since some medication may induce drowsiness while other medication may affect heart rate, blood pressure, and circulation.

SAVE ALL INSTRUCTIONS

NOTE: Check with your state/local code enforcement officer to determine electrical code requirements and compliance. Use a qualified licensed electrician to complete all final spa electrical connections.

Caution: Risk of electrical shock. Read and follow all instructions.

TO AVOID RISK OF ELECTRICAL SHOCK:

1. A green colored terminal or a terminal marked G, GR, Ground, Grounding, or the international symbol  is located on the side of the supply terminal box or compartment. This terminal must be connected to the grounding means provided in the electric supply service panel, using a continuous copper wire equivalent in size to the circuit conductors supplying this equipment.
**IEC Publication 60417, Symbol 5019.*
Never use aluminum wire.
2. At least two lugs marked "BONDING LUGS" are provided on the external surface or on the inside of the supply terminal box or compartment. Connect the local common bonding grid (house-hold ground) in the area of the hot tub or spa to these terminals, using an insulated or bare copper conductor not smaller than No. 6 AWG.
3. All field-installed metal components such as rails, ladders, drains or similar hardware located within 5 ft (1.5m). of the spa or hot tub shall be bonded to the equipment grounding bus with copper conductors only, no smaller than No. 6 AWG.
4. Never connect unit to a power supply with a load controller.
5. Install spa in position which provides drainage of electrical component compartments.
6. The electrical supply for this product must include a suitably rated switch or circuit breaker to open all ungrounded supply conductors. This disconnecting means must be readily accessible for operation but installed at least 5 feet

(1.5m) from the spa. All electrical connections should comply with local regulations.

DOS AND DON'TS OF SPA CARE

Do:

- Save these instructions!
- Replace the cover immediately after use.
- Keep the cover locked when spa is not in use.
- Be aware of the dangers of a wet and slippery surface. Use caution when entering and exiting your spa.
- Have a licensed electrician or certified technician make all final electrical connections.
- Replace worn, frayed or broken electrical cords.
- Keep the water chemistry correctly balanced. Untreated spa water will cause problems with your spa and equipment as well as being a health risk.
- Clean the spa filter weekly or as needed.
- Position the spa so that all sides remain accessible for maintenance.
- Use a bathing cap for long hair.
- Refer to information on hyperthermia.
- Use only authorized spa care products for the best performance and to keep the water properly balanced.

Don't:

- Use the spa at 104°F (40°C) for long periods of time (more than 30 minutes). See Hyperthermia, next column.
- Use an extension cord to power your spa.
- Allow anyone to stand on the spa cover. It is not designed to support weight.
- Power the spa unless it is filled with water 5-6 inches below top of spa lip.

- Operate the pump on high speed for extended periods of time with the cover in place. Extended operation can cause heat build-up and interfere with spa operation.

HYPERTHERMIA

The causes, symptoms, and effects of hyperthermia may be described as follows: hyperthermia occurs when the internal temperature of the body reaches a level several degrees above the normal body temperature of 98.6°F (37°C). The symptoms of hyperthermia include an increase in the internal temperature of the body, dizziness, lethargy, drowsiness, and fainting. The effects of hyperthermia include:

- a. Failure to perceive heat
- b. Failure to recognize the need to exit spa or hot tub
- c. Unawareness of impending hazard
- d. Fetal damage in pregnant women
- e. Physical inability to exit the spa or hot tub
- f. Unconsciousness resulting in the danger of drowning

WARNING - The use of alcohol, drugs, or medication can greatly increase the risk of fatal hyperthermia.

SPA INSTALLATION

The electrical supply for this product must include a suitably rated switch or circuit breaker to open all ungrounded supply conductors to comply with Section 422-20 of the National Electrical Code ANSI/NFPA70-1987. The disconnecting means must be accessible but installed at least 5 feet (1.5 m) from the spa water. All electrical connections should comply with article 680-D of the NEC.

EUROPEAN SPAS

The appliance should be supplied through a residual current device (RCD) with a rated tripping current not exceeding 30 mA. Means for disconnection must be incorporated in the fixed wiring in accordance with the wiring rules. Parts containing live parts, except parts supplied with safety extra-low voltage not exceeding 12 V, must be inaccessible to a person in the bath. Earthed appliances must be permanently connected to fixed wiring.

SPA SITE AND POSITIONING

Locate the spa on solid, level foundation or flooring, keeping in mind the weight of the filled spa in excess of 3,968lbs (1.800 kg) on some models. If you have any doubts about the load bearing ability of your chosen site, contact an architect/building contractor. The entire perimeter of the spa cabinet and spa bottom must be evenly supported. If your spa is installed outdoors, we recommend you provide a concrete pad for the spa to rest on 8ft x 8ft x 4in (2.5m x 2.5m x 10cm). Failure to provide a level surface could structurally damage your spa and void the warranty. The spa must be installed to allow access for service and maintenance on all four sides; therefore, below grade level or below deck installation is not recommended.

OUTDOOR INSTALLATION, Consider the following:

1. Local codes pertaining to fencing.
2. Local electrical and plumbing codes.
3. View from your house.
4. Wind direction.
5. Exposure to sunlight.
6. Distance to trees (twigs, leaves and shade).
7. Dressing and bathroom location.
8. Storage area for equipment and chemicals.
9. Location to facilitate adult supervision.
10. Landscaping and nighttime lighting.
11. Accessibility to equipment.
12. Power supply location and foot traffic.

INDOOR INSTALLATION, Consider the following:

1. Indoor spas promote high humidity. Using ventilation fans or commercial grade dehumidifiers will help to reduce humidity.
2. Floor drains must be provided near the spa to drain off water that may cause falls and/or water damage.
3. Floor area should be flat with a non-skid finish. Carpeting is not recommended.
4. Walls/ceilings should be made of materials able to withstand high humidity.
5. Floor load bearing capacities must be able to support the concentrated spa weight.
6. Spas should be double checked for leaks before installing to avoid possible water damage. Dealer installation may include this service.
7. Indoor sun rooms can maintain high ambient temperatures which may effect the spa water temperature. It is NOT recommended that you operate your filter cycles for longer than 4 hours per day under these conditions.

8. For units for use in other than single-family dwellings, a clearly labeled emergency switch shall be provided as part of the installation. The switch shall be readily accessible to the occupants and shall be installed at least 5 feet (1.52 m) away, adjacent to, and within sight of the unit.
- hot tubs. It is not an indication that something is wrong with your spa or its equipment.

Danger: Electrical shock risk. Install at least 5 feet (1.5m) from all metal surfaces

IMPORTANT: Proper drainage must be provided to keep base dry, especially if installed below ground/in a pit.

THERMAL CREEP

Your spa is manufactured with energy-efficient components and systems that capture heat generated by the equipment, then transfer that heat back to the spa water. In warmer weather or in situations with extended run times, "Thermal Creep" may occur. Thermal Creep is a condition whereby the actual water temperature is higher than the set temperature. To manage "Thermal Creep" you may:

- Vent your cover. Newer covers have removable center seal padding. To remove this padding, open the Velcro on one side of the vinyl pouch and slide the white padding out. If your spa does not have removable center seal padding, you may instead place a folded cloth about ¾" (2cm) thick under all four corners of the cover before you lock it down. Opening the cover at night will also quickly cool the water down if desired.

- Open all air controls
 - Set your filtration cycles to run during the cooler times of the day or at night
 - Reduce the length of your filter cycles
 - Visit your local dealer for additional guidance
- Thermal Creep only occurs in well-insulated

SPA SYSTEM COMPONENTS

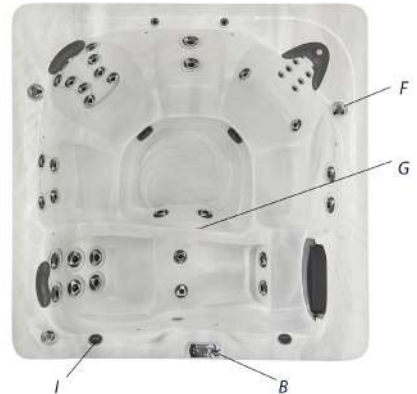

- A. Filter Skimmer/Weir: Removes floating debris from the water surface, provides a water return path to equipment, and houses water filter element.
- B. Topside Control Panel: Used to control temperature setting, pump for jets, and light.
- D. Manufacturer's Identification Label: Contains identification information for warranty service (serial number, model number, etc.) and electrical information (amperage rating and amperage requirements).
- E. Equipment Pack Service Panel (no user serviceable parts): Spa support system consisting of 2-speed pumps, heater, and associated electrical controls are inside this front panel (not shown).
- F. Air Controls: Increases or decreases air entering the jets. Close during heating for maximum efficiency.
- G. Digital/Fiber Optic Lighting: Lighting system that displays multiple colored lights in pre-programmed random, solid or alternating colors (not shown).
- I. Stereo/Speakers
- J. Drain Access: (Adjacent to the equipment service panel) Spa drain faucets.

SPA COMPONENTS

Reference only. Equipment is not always as shown.

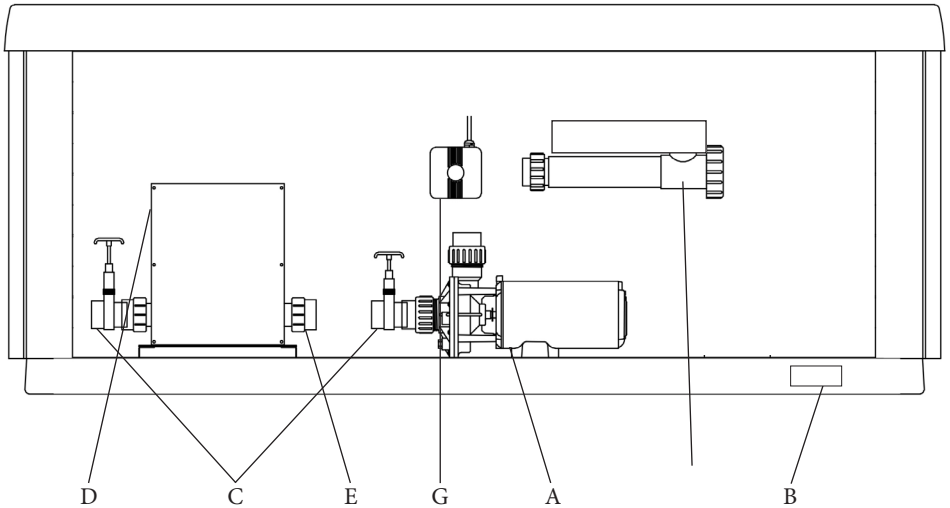

- A. Pumps (one pump or more, depending on model): Low speed for efficient water circulation during filtration and heating; high speed for maximum action of the jets. The pump functions are activated by topside controls.
 - B. Manufacturer's Identification Label: Contains identification information for warranty service (serial number, model number, etc.) and electrical information (ampere rating and ampere requirements).
 - C. Slice Valve: Used to shut off water flow from the spa to the equipment while servicing. Quantity will vary depending on model. All should be open during normal operations.
 - D. Electrical Connections: Electrical inputs/wires for the unit connect here.
 - E. Heater Assembly: Thermostatically controlled and equipped with an overheat safety shut-off.
 - G. Ozone Generator (Optional)
 - H. UV System (Optional)
- Note: No consumer serviceable parts. Do NOT attempt to service any of these components yourself. Contact your dealer for assistance.

JETS AND AIR CONTROLS

JETS

All spa jets are individually engineered to provide a unique hydro-massage. Depending on the model, your spa will have a combination of the following jets.

Swim Spa Jets

Swim spa jets are designed to produce a smooth flow of water with high output to create a consistent swim stream. Whether you want to swim or walk/jog against the force of the jets, you will find the flow of water deep enough and swift enough to meet your individual needs.

Hydrotherapy Area Jets

All spa jets are individually engineered to provide a unique hydro-massage. Depending on the model, your spa will have a combination of the following jets.

Directional Jets

Positioned to focus on large muscle groups, these jets deliver a concentrated, high volume stream of water for a deep massage. Each jet is fully adjustable, allowing users to set the water flow to the most comfortable setting. Nozzle can be rotated to target sore muscles.

Rotating Jets

Positioned to focus on muscle tension zones, these jets deliver a spinning V-shaped water stream for a gentle, pulsating massage. Each jet is fully adjustable, allowing for comfortable water flow settings for everyone to enjoy.

Euro Jets

Positioned in the foot well or shoulder areas, these jets deliver a penetrating massage to

dissolve tension. This jet may be the entry point for ozone produced during automatic filtration and therefore it is not adjustable.

Note: Ozone production is stopped when functions are activated on control panel.

CLEANING OR REPLACING JETS

Hard water can cause calcium/mineral buildup that can restrict or bind the jets. A jet consists of a face plate and a nozzle. Rotate these parts weekly and remove/clean to ensure free movement, including the aurora cascades jets.

NOTE: It is not necessary to drain the spa to clean or remove the jets.

Rotating Jets

- Rotate the jet face left and right
- Return face plate to full open position
- Turn the jets on high speed
- Twist the nozzle left and right
- Rotate the nozzle in the socket

NOTE: If the jet insert disengages from the spa housing, see steps to reinstall below.

CLEANING JETS

- To REMOVE the jet insert, use the palm of your hand to exert pressure on the face of the jet. Turn counterclockwise until the jet 'clicks'. Gently pull the jet assembly from the housing.
- To REMOVE the smaller adjustable jet insert, wear latex or rubber gloves. Turn counterclockwise until you reach the stopping point. Exert more pressure to turn past the stopping point and as the jet 'clicks' pull the insert toward the center of the spa. Gently pull the jet insert from the housing.
- To CLEAN the jet insert and housing, use a

pressurized hose and spray the inside of the jet. Soak the jet in a diluted spa cleaning solution, rinse. Wipe the inside of the housing to remove any debris.

- To REINSTALL the jet, line up the tab on the backside of the barrel with the groove in the body. Use the palm of your hand to gently tap the jet until it snaps into position.

**NEVER SHUT ALL FULL SIZED
JETS OFF AT ONE TIME!**

AIR CONTROLS

The intensity of the jet action can be controlled by altering the amount of air injected with water through the jets. Your spa has one or more air controls located on the lip of the spa. Each control activates air to specific jets in the spa allowing you to create various combinations and levels of jet action to suit individual preferences. Turn the control counter-clockwise to turn the air off and clockwise to turn air on.

NOTE: Air controls should be closed during heating cycles for maximum energy efficiency.

NOTE: At the start of a filtration cycle, the Optional Air System is activated to purge the lines and ensure complete filtration. Ensure that at least one air control is always fully open.

Waterfall On/Off Valve: Turns on or shuts off the flow of water to multiple jets or the waterfall. This valve should be tested weekly to clean the lines and to help prevent debris build up.

Diverter Valve: Diverts water from one set of jets to another. This valve should be tested

weekly to clean the lines and to help prevent debris build up.

NOTE: The diverter and on / off valve(s) should be cleaned regularly. Remove the handle by pulling upward and rocking it back and forth, unscrew the cap and pull the valve stem out. To clean the valve stem and housing, use a pressurized hose and spray the inside of the valve housing. Soak the valve stem in a diluted spa cleaning solution, rinse. Wipe the inside to remove debris.

NOTE: The diverter and waterfall on/off valve(s) should be adjusted regularly. When exiting the spa it is recommended that you leave the larger diverter valve(s) in the middle position so water circulates through all the jets attached to it. It is also recommended that you do not turn the smaller on/off valves completely off to allow warm sanitized water to flow through the jets or water features during programmed filtration cycles. When adjusting a valve that controls a water feature that shoots water above the lip of the spa it is important that the water feature NOT get enough water to hit the spa cover. This may allow water to exit the spa causing a low water condition.

ELECTRICAL INFORMATION

**Caution: Risk of electrical shock.
Read and follow all instructions.**

IMPORTANT SAFETY INSTRUCTIONS

All electrical connections to this spa package **MUST** be done by a qualified licensed electrician or certified technician in accordance with National Electrical Code (NEC) and with state/local electrical codes in effect at the time of installation.

NOTE: Prior to performing any service to the spa equipment, turn OFF all primary electrical power at the main circuit breaker or disconnect panel.

To make spa electrical connections, remove the exterior equipment access panel, locate the electrical control box, remove the control box cover and follow the wiring diagram on the inside of the control box cover.

Connections should be made using copper conductors only; DO NOT use aluminum. Connecting wires, circuit breakers or fuses must all be sized to accommodate the Total Ampere load as specified on the equipment label.

This equipment is designed to operate on 50Hz or 60Hz alternating current only, at 240 volts or 120 volts, as required.

NOTE: All unions must be hand-tight and all slice valves must be locked in the OPEN position before filling or refilling spa! A clip is provided to help keep the slice valve open. Run spa and check for union water leaks before reinstalling front panel.

FOR EUROPE ONLY

The spa is intended for use only in premises having a service current capacity ≥ 100 A per

phase, supplied from a distribution network having a nominal voltage of 230 V. The user shall determine in consultation with the supply authority, if necessary, that the service current capacity at the interface point is sufficient for the spa.

Equipment complying with IEC 61000-3-11.

GFCI

(Ground-Fault Circuit Interrupter)

A qualified licensed electrician must connect the spa to a circuit protected by a GFCI. This is a requirement by the National Electric Code, article 680.44, and is also in compliance with Underwriter's Laboratories, Inc.

RESIDUAL CURRENT DEVICE

The appliance should be supplied through a residual current device (RCD) or Ground Fault Interrupter (GFCI) with a rated tripping current not exceeding 30mA. Means for disconnection must be incorporated in the fixed wiring in accordance with the wiring rules. Parts containing live voltage, except parts supplied with safety extra-low voltage not exceeding 12V, must be inaccessible to a person in the bath. Earthed appliances must be permanently connected to fixed wiring.

INSTALLATION OPTIONS

Refer to the manufacturer's nameplate located on the kick plate to determine your spa's amperage requirements.

Note: Copper wire is strongly recommended for all electrical connections.

Spas installed for 120 volt operation require a 3-wire, 40, 30, 20 or 15 amp., 120 volt

sub-feed in non-metallic pipe to the spa equipment compartment (line 1, neutral and ground). A green colored terminal (or wire connector marked "G", or "GR", or "Grounding") is provided in the control box. To reduce the risk of electrical shock, connect this terminal or connector to the grounding terminal of your electrical service or supply panel with a continuous green insulated copper wire equivalent to the circuit conductor supplying this equipment, but no smaller than No. 12 AWG. A second pressure wire connector is provided on the surface of the control box for bonding to local ground points. To reduce the risk of electrical shock, this connector should be bonded with a No. 6 AWG copper wire to any metal ladders, water pipes, or any metal within 5 ft. of the spa.

Spas installed for 240 volt, 60 Hz, single phase operation require a 4-wire, 60, 50, 40 or 30 amp., 240 volt sub-feed in non-metallic pipe to the spa equipment compartment (line 1, line 2, neutral and ground). A green colored terminal (or wire connector marked "G", or "GR", or "Grounding") is provided in the control box. To reduce the risk of electrical shock, connect this terminal or connector to the grounding terminal of your electrical service or supply panel with a continuous green insulated copper wire equivalent to the circuit conductor supplying this equipment, but no smaller than No. 12 AWG. A second pressure wire connector is provided on the surface of the control box for bonding to local ground points. To reduce the risk of electrical shock, this connector should be bonded with a No. 6 AWG copper wire to any metal ladders, water pipes, or any metal within 5 feet (1.5m) of the spa.

A pressure wire connector is provided on the exterior surface of the control box inside the spa. This is to permit the connection of a ground bonding wire between this point and any metal equipment, enclosures, reinforced concrete pad, pipe, or conduit within 5 feet (1.5m) of the spa (if needed to comply with local building code requirements). The bonding wire must be at least a #10 AWG solid copper wire.

Bond the spa to all exposed metal equipment or fixtures, handrails, and concrete pad per N.E.C. Article 680 and all local codes.

1. Push the "TEST" button on the GFCI/RCD breaker. The spa should stop operating and the GCFI power indicator will go out.
2. Wait 30 seconds, then push the "RESET" button. Power will be restored to the spa and the GFCI/RCD power indicator will turn on. If the GFCI/RCD fails to operate in this manner, your spa may have an electrical malfunction, and you may be risking electrical shock. Turn off all circuits and do not use the spa until the problem has been corrected by an authorized service agent.

WARNING: Removal of the GFCI/RCD from the spa's power cord will result in an unprotected spa and will void the spa's warranty.

IMPORTANT: Should you ever find the need to move or relocate your spa, it is essential that you understand and apply these installation requirements. Your spa has been carefully engineered to provide maximum safety against electrical shock.

VOLTAGE/AMPERAGE CHART:

240 Volt Installation Units

Electrical Requirements

Requirement

- 240 volt/60 amp, 50 amp, 40 amp, or 30 amp.
- 60 Hz
- Single phase
- 4-wire service (line 1, line 2 neutral and ground)

NOT NORTH AMERICAN

- 240 volt
- 50 Hz
- Single-, two-, or three- phase service
- Refer to wiring diagram or pouch on control system inside cabinet for specific wiring and phase information.

THIS SECTION

**APPLIES TO SPAS
INSTALLED OUTSIDE
OF NORTH AMERICA**

Number	Meaning
1	The heater will only remain running with no more than two pumps on high speed. All pumps will run on high speed when heater is off.
2	The heater will only remain running with Pump 1 on low speed. Only the spa light can operate at the same time without disabling the heater. All pumps will run on high speed when heater is off.

DEDICATED 240V UNITS North America

MODELS	240V/60A	240V/50A	240V/40A	240V/30A
DM8 (Spa Side)			1	2
DM8 (Swim Side)	1	2		
MX6	1			
MB4	1	2		
ML4	1	2		
RB4	1		2	
RL4	1		2	
RF2	1	2		
982	1			
880	1	2		
881	1	2		
481	1		2	
480	1		2	
472	1		2	
471	1		2	
470	1		2	
460	1		2	
461	1		2	
451			1	2
282	1		2	
281	1		2	
280	1		2	
271	1		2	
270	1		2	
261			1	2
250			1	2
171	1		2	

See previous page for explanation of corresponding numbers.

START UP PROCEDURES

Follow recommendations for site location and electrical connection. 6" (15.5cm) below the top lip of the spa is the level at which the water should be maintained.

1. Fill the spa through the filter hole to 6" (15.5cm) below the top of the spa with tap water. Never use 'softened' water in your spa. Softened water can impact the chemical balance of the water and lead to degradation of metal plumbing fittings and possible jet plastic damage.
2. After you have assured that the spa/swim spa is full of water and that all plumbing valves are open, turn power on to unit at circuit breaker or disconnect panel.
3. Open the air controls, located on the top lip, and cycle the jets from high to low. Water should come from the therapy jets. If water flow is not established, turn off jets and see Priming Your Spa (next column).

Important: Do not operate the spa without full water flow.

4. Add chemicals. See Chemical Treatment and Water Maintenance section. Follow Operating Insutructions for your particular model to set heat to the desired temperature. Initially, you may find that the spa requires 12 to 14 hours (18 to 24 hours for swim spas) on 230 Volt installations to reach temperature. Keep your thermal cover on the unit and close the air controls to help the heating process.
5. Verify all drain valves are closed, some are under the spa.

PRIMING YOUR SPA

When filling your spa for the first time or after draining and refilling the spa, you may need to bleed air from the system. Should you experience an air-lock on Pump 1, remove the filter cover, insert a garden hose through each center hole that holds the filter as far as possible without using force. Hold the hose in place and turn on the water. Cycle pump 1 from low to high several times, this forces water into the pump and forces the air out. If this does not work or you experience an air-lock on Pump 2, remove the side panel and locate the pump. With the pump on high speed, slowly loosen the discharge (top) pump union until water starts to trickle out. Once water is trickling out, hand tighten the union (do not over tighten as this could cause the union to crack) and replace the side panel.

Pr - Prime/Purge Pumps

This is Not an Error Message. The Spa has just been powered up and is in Priming Mode for 4 Minutes. Pumps can be turned ON and OFF to remove any air from the plumbing lines and the Heater. Cycle the pumps on and off to verify good water flow and wait 4 minutes or press any temp related button to exit Priming Mode.

CONTROL PANEL TYPES AND MODELS

in.k500 Control Panel



This easy to use control has been programmed to be “plug and play.” Turn the power on, adjust the desired temperature and the system is ready to go. If there are situations that require additional filtering time, the filter settings can be customized to any special requirements. Simple to use and easy to read, the POWERWORKS® Control System makes controlling the spa effortless.

CONTROL PANEL OPERATION

Please note: All pumps and light have an automatic timeout (shut-off) programmed 30 minutes after the pump or light is activated. Lights have an automatic shut-off after 60 minutes.

Power

Press any key to turn the control panel on. After 30 minutes without activity, it will shut off.

Main Screen

The main screen provides access to your accessories and water temperature. At the bottom of the screen you will see any error or maintenance messages that are present.



Start or Stop Accessories

To start or stop an accessory, press the associated button. Icons will become animated when their accessory is turned on, and inanimate when turned off. Icons on the screen will reflect the speed or state of the devices running on your spa.

When an accessory has more than two states, press the button until it reaches the desired state.



Water Temperature

The temperature shown at the top of the screen (in white) is the actual water temperature. Use the Up and Down keys to set the desired temperature. The set temperature will appear in blue at the bottom. After 3 seconds without any change to the temperature value, the current water temperature will reappear.

When the set temperature is lower than the current water temperature, Cooling to **XX**°F will appear on the bottom of the screen. When the set temperature is higher than the current water temperature, Heating to **XX**°F will appear. Normally there is a brief delay before the heating starts, during which Heating Suspended is indicated on the screen.



Note: a "Cooling" message does not necessarily indicate that your spa is equipped with optional cooling equipment (e.g. heat pump)

Settings

Access the Settings by a press of the **Settings** key from the home page. The following categories will appear on the Settings menu:

- Water Care
- Audio
- Date & Time
- Keypad Settings
- Electrical Configuration
- About

Use the **Up** and **Down** keys to move up or down in the menu. To select an option, press the lit key beside it (**Pump2** key). At any point, a press of the **Settings** key will return to the home page.



Water Care

The water care section will help to select the ideal filtration and heating settings. Choose from *Away*, *Standard*, *Energy Savings*, *Super Energy Savings*, and *Weekender*, depending on your need. Use the Up and Down keys to choose your setting. To select a mode, press the lit key beside it (Pump 2 key) A checkmark will appear on the selected icon to confirm.



Water care modes



Away:

In this mode the spa will always be in economy; the set point will be reduced by 20° F*.



Standard:

The spa will never be in economy mode and will be filtering according to the pack's low level configuration.



Energy Savings:

The spa will be in economy mode during the peak hours of the day and resume normal mode on the weekend*.



Super Energy Savings:

The spa will always be in economy mode during peak hours, every day of the week*.



Weekender:

The spa will be in economy mode from Monday to Friday, and will run normally on the weekend*.

**Filtration will be reduced when the economy mode is active.*

Filtration System

The spa is factory programmed to filter the water. The schedule and duration depend on the water care mode selected, and can be modified as needed (please see the Modifying Schedules for instructions). The filtration cycles occur in two steps: a purge step and a clean step. During the purge step, typically, all pumps are turned on for one minute to purge the spa plumbing. For the remainder of the filtration cycle, pump #1 low speed will operate to perform the clean step.

The filtration cycle can be suspended by pressing any of the pump keys. The filtration cycle will resume after 40 minutes from the last key pressed.

Modifying Schedules

To see and/or modify a Water Care category, use the lit button to the right (Key 1) to open the selected Water Care menu.

Use the arrow keys to choose a schedule to modify. You have several possibilities for the schedule (mon-Fri, weekend, every day, or single days). The schedules will be repeated every week. The time and duration are set in 30 minute increments. Once you have set the schedule, use Key 1 to go back. Ensure that you have selected the desired Water Care option in the main Water Care menu.



Audio

The Audio section in the Settings menu of an in.k500 gives you the option to connect or disconnect your Bluetooth enabled device when using the in.stream2. The audio option will only appear in the menu on spas that are equipped with the optional Bluetooth Music System. The in.stream 2 is automatically detected at power-up.



Date & Time

Here you can adjust the time format, change the year, date, and time. Use the arrows to choose the setting that you want to adjust and select it by pressing the Light key.

Use the arrow buttons to change the parameters, and the Light key to move between parameters. Key 1 will take you back to the main Setting menu.



Keypad Settings

In this section, you can change the temperature unit, language, display orientation, and keypad security. You can lock the keypad by selecting one of 3 security levels: Unlock, Partial, or Full. The partial level locks the set point adjustment and many options in the settings menu. The Full level locks all keypad functions. To unlock the keypad (either Partial or Full), press and hold the Light key for 5 seconds.



Electrical Configuration

Please do not make any changes in this section. Changes made in this section may cause components to become inoperable.



Wi-Fi

This menu allows you to view an optional in.touch2 module's connection to a Wi-Fi network.

To review its connection to a wireless network, use the Up/Down keys to go to the WiFi option in the Settings menu and Light key to select it.

Use the Up/Down keys to move through the list and use the Light key to select your network.

- Use Key 2 to move the cursor forward
- Use Key 1 to backspace
- Use the Light key to confirm



About

This selection displays the software information of the control panel and control pack.



FEATURE OPERATIONS

JET SELECTOR VALVES (DIVERTER VALVES)

Your spa may be equipped with a jet selector valve (diverter valve). This valve can be used to divert jet power from one area in the spa to another area. This valve is fully adjustable and can be used to suit the user's desired effect. The valve may be slightly harder to turn when the jet pump is on high speed. This is normal due to high rate of water flow and pressure present in the valve.



AIR CONTROL VALVES

Your spa may be equipped with air controls. The air control is an on/off valve that allows air to be introduced into a specific jet configuration resulting in a more vigorous jet action. This valve looks similar to the jet selector valve (diverter valve), however it is smaller in size, and it has the word AIR on the handle. Turn the valve handle clockwise to turn the air on, and counterclockwise to turn the air off. Opening the valve increases jet pressure and closing the valve decreases the jet pressure.



WATER FEATURE/WATERFALL CONTROL VALVE

Your spa may be equipped with a waterfall or water feature(s) that is controlled by a water feature/waterfall control valve. This valve looks identical to the air control valve but without the word AIR on the handle. Turn the valve handle clockwise to turn the water feature(s) on, and counterclockwise to turn the water feature(s) off.



in.stream2 AUDIO SYSTEM

Your spa may be equipped with a stereo system. Please refer to the separate Audio Set-Up Guide for the operation of the stereo system.

IN.TOUCH2 SYSTEM

Your spa may be equipped with the in.touch WiFi system. This system allows the use of an Apple™ or Android™ device to control the spa. Please continue to the next page for basic set-up instructions.

in.touch2 BASIC SET-UP INSTRUCTIONS

Simplest of Setups

in.touch 2 eliminates all the complexities of connecting your spa to the Internet and transforms your smartphone or tablet into your ultimate Wi-Fi spa remote control. in.touch 2 comes with a state-of-the-art app and 2 prepared radio frequency transmitters, one being part of your spa system and the second one being connected to your Internet router. Both RF transmitters are prelinked to one another, enabling an immediate and perfect communication between you and your spa.

Strong & Long Range Communication Signal

Through their proprietary RF technology, in.touch 2 transceivers emit a strong, stable and long range signal between your spa and your router (about 3 times longer than regular Wi-Fi signal). No need for repeaters or boosters: your spa will always remain within reach in typical backyard settings.

State-of-the-art App with Push Notifications

in.touch 2 streamlined application makes it very easy to control and program all the functions and features of your spa from your smartphone or your tablet. Even when you're away from home, you get full control of your water care settings, filtration cycles, water temperature, economy modes and a lot more. Push notifications will always keep you informed on the status of your spa, even when your app is not open.



Each in.touch2 module has a status LED that can be used for troubleshooting purposes. The LED is located on the top of both enclosures.



EN Module (home)

Pairing mode	Yellow (Blinking)
Router not detected	Red
Router detected	Green
in.touch 2 server detected Module is fully functional	Blue

CO Module (spa)

Pairing mode	Yellow (Blinking)
Spa controller not detected	Red
in.touch 2 server detected Module is fully functional	Blue

* When the LED status is blinking (blue, green or red) this indicates that the communication between the EN module and the CO module is not established.

Download Application

The in.touch2 app allows you to control your spa using your home network or an Internet connection anywhere in the world. The in.touch2 app can be found in the App Store for iOS devices - search for <in.touch 2> then click to install.



Using the App

Using the app

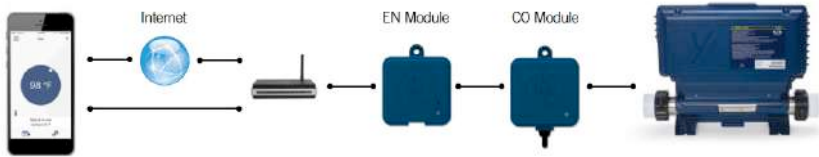

On Your Home Network

It is possible to access your spa with the in.touch 2 app through your home network. To be able to see your in.touch 2 in the application you need to connect your device to the same router (Wi-Fi network) than the one used to connect your in.touch 2-EN module.

Go to the Wi-Fi settings section of your mobile device and choose the same network that your spa is connected to (i.e. Home). Once you've selected it, wait until your device confirms the connection.

On the Internet

The in.touch 2 allows you to use the Internet to control your spa from anywhere in the world. In order for them to communicate, both the in.touch 2 module and your device must be connected to a network that allows access to the Internet.

Once your in.touch 2-EN module is connected to the Internet (the LED status is blue), you can use your in.touch 2 app any time your device is also connected to the Internet (wireless or cellular network), even if you are away from home.

To have access to your spa away from home, you will need to have previously linked your mobile device to your spa on your home network.

Setup your Wi-Fi on your iOS Device

Before using your application, go to the Wi-Fi section of your device's settings.

Make sure you are connected to your home network.

This needs to be the same Wi-Fi provided by the router to which you connected your in.touch 2-EN module.



Start the in.touch 2 Application

Find the icon for the in.touch 2 application, then tap on it to open it.



The first time you use the application a message will ask you: "in.touch 2" Would like to send you notifications. If you choose Allow, the application will send you notifications about the status of your spa. If you choose Don't Allow, the application will not send you notifications.

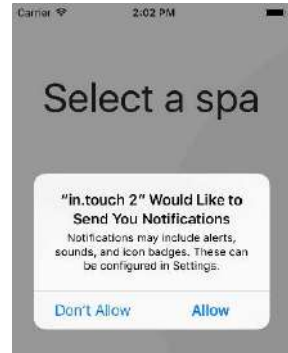

If you change your mind later concerning notifications, you may add or remove notifications for the in.touch 2 application. Go in your settings menu in your iOS device and choose in.touch 2. Select the notifications menu, you can turn notifications on or off from this page.









Select a Spa

This page displays all the spas detected by your application.

To detect your spa, you need to connect your mobile device to the same network to which you connected your in.touch 2-EN module.

Once you have done a connection with the spa its name will be saved on this page to allow you to connect to this spa from anywhere.

The RF signal strength (communication between the two in.touch 2 modules) is illustrated on the Select a spa page. There are 6 possible states:

-  • Signal superior to 80%
-  • Signal between 80% and 51%
-  • Signal between 50% and 31%
-  • Signal below 30%
-  • The in.touch 2 CO (spa) module is not available
-  • The in.touch 2 EN (home) module is not available

To delete a spa from this list, slide the spa name to the left and tap on Delete.

Home Page



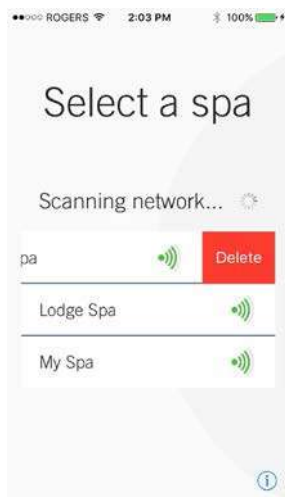



The main screen gives you access to your accessories, water temperature, water care and settings.



Note: If you are currently connected on the same local network as your spa and try to delete it, this one will reappear as soon as the menu refreshes.

Spa State

This page displays all the active states of your spa. Below is a quick description of each state you may encounter on your spa. Each state is associated to a priority and color that determines the color of the widget on the home page.

-  Indicates that there is an error on your spa.
-  Indicates that there is presently an active user demand on your spa (ie. pump, blower or light is on).
-  Indicates that your spa is now heating to your set point.
-  Indicates that your spa is now in a filtering cycle.
-  Indicates that your spa is now in economy mode.
-  Indicates that your spa is running normally (there is no user demand, heating, no filtration or economy active).

The widget on the home page displays a single color at a time. The color displayed is decided by priority of state. The established priority is as listed above.

Settings

In the Settings page you can access the following:

- Wi-Fi
- in.touch network
- Tips
- Temperature units
- About

To select an item, tap on the arrow next to it. It will open the selected menu.

Wi-Fi

In the Settings menu the Wi-Fi line indicated to which network your mobile device is actually connected.

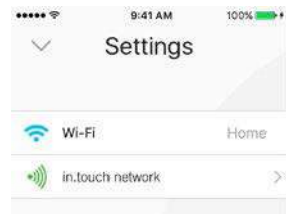

in.touch2 network

The in.touch2 network menu allows you to have access to information concerning the RF connection parameters between the in.touch 2- EN and in.touch 2-CO modules.

This menu gives you access to:

- Channel
- Signal strength
- Reset channel (resets channel to default)

To change channels, press on the Channel line.

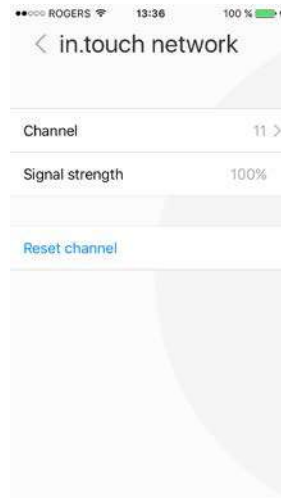

Change Channel

The Change channel page allows you to change the channel used by the two in.touch 2 modules.

In some cases it is possible this will help you to have a stronger signal.



WATER BALANCE

WATER CHEMISTRY

Maintaining proper water chemistry is imperative to maintaining safe water and preventing possible damage to your spa and spa components.

START-UP PROCEDURES

1. Fill spa to correct level (approximately 5" below the top of spa). Keep spa cover open while treating water.
2. When utilizing the Aqua Klean® filter bag, you may add stain and scale control, or a similar sequestering agent, such as Metal Gone.
3. Test and adjust total alkalinity – run pump for ½ hour.
4. Test and adjust pH – run pump for ½ hour.
5. If sanitizing with bromine, add sodium bromide with jets running (*see Bromine section*).
 - a. Fill and set bromine floater or adjustable bromine feeder and place in the spa water.
 - b. Shock water with potassium peroxydisulfate (such as "Renew") with jets running.
6. If sanitizing with chlorine, use only a granular "Dichlor" compound (*see Chlorine section*).
 - a. Fill and set chlorine floater or chlorine feeder and place in the spa water.
 - b. Shock water with potassium peroxydisulfate (such as "Renew") with jets running.
7. Run pump for ½ hour.
8. Wait ½ hour after introducing the last water treatment (e.g. Metal Gone, Renew, Chlorine) before closing spa cover.

WATER QUALITY

Your spa is equipped with a specially designed Aqua Klean® filter system. Filtering the water helps maintain water cleanliness and clarity. While the filter traps most solid materials, it is still necessary to add a sanitizer such as bromine or chlorine to the water in order to control bacteria, algae, and to oxidize any organic materials in the water.

We recommend that you purchase your chemicals from your authorized American Whirlpool dealer. The dealer can also advise you on alternative methods for water sanitation. **Use of incorrect chemicals can be dangerous and may void the warranty on your spa.**

pH CONTROL

All water has a pH value determined by a scale of 0-14, which is a measure of the acid to alkaline relationship. While a pH reading of 7.0 is considered neutral, a lower reading is considered acidic and a higher reading is alkaline. The proper pH for spa water is between 7.2-7.6. High pH (above 7.8) can reduce sanitizer efficiency, cloud the water, promote scale formation on spa surface and equipment and interfere with filter operations. When pH is too high, add a pH decreaser. Low pH (below 7.2) is equally damaging and can cause equipment corrosion, water that is irritating, and rapid sanitizer dissipation. Add pH increaser to adjust the level. Follow the chemical manufacturer's directions and procedures when adding chemicals to spa water.

NOTE: Always add pH adjuster with jets operating and circulate all chemicals for at least 30 minutes. Remember that good pH control and sanitation are absolutely essential for proper spa water treatment.

TOTAL ALKALINITY

Total alkalinity is the amount of carbonate, bicarbonate, and hydroxyl ions in the water. Total alkalinity affects and buffers the pH of the water. With high total alkalinity (above 160), pH resists adjustment. With low total alkalinity (below 130), pH is unstable and difficult to keep in the ideal range. Proper total alkalinity levels allow other spa chemicals to work effectively.

WATER TREATMENT

SANITIZERS

The importance of maintaining an adequate level of sanitizer in your spa cannot be overemphasized. Warm water presents a fertile environment for the growth of bacteria and viruses. This growth is prevented when adequate sanitizer levels are continuously maintained.

WARNING – Sanitizers such as tri-chlor (tablets or sticks), calcium hypochlorite, sodium hypochlorite, and any chemical that dissolves on or remains un-dissolved in contact with the spa surface will damage your spa surface and will void the warranty completely.

BROMINE

Bromine is the most common sanitizer used in spas. Adjust the floater to maintain a total bromine level of 3.0-5.0 ppm. If the reading is below the minimum, raise the level before using the spa. If the reading is above 5.0 ppm, allow ppm to drop to the proper range before using the spa. Brominating tablets are a convenient and effective source of bromine for your spa. Do not drop bromine tablets directly into the water as this may damage the spa surface. A chemical “floater” safely and properly dispenses the tablets into the spa water. When used properly, brominating tablets will keep your water clean, clear, and odor-free. To ensure maximum effectiveness, add ½ oz. of sodium bromide per 100 gallons of water every time you fill your spa. This will establish a bromide reserve.

CHLORINE

Chlorine is a water sanitizer also, however it is more sensitive to pH than bromine. To be effective, you must have a pH range of 7.2-7.6. Any reading outside this range will greatly reduce chlorine effectiveness.

Use a chlorine test kit or test strip to maintain a reading of 2.0-3.0 ppm of free chlorine. If the reading is below the minimum, raise the level before using the spa. If the reading is above 5.0 ppm, allow ppm to drop to the proper range before using the spa. Read the instructions on your chlorine container carefully, or consult your local L.A. Spas dealer if you are having difficulty adjusting your chlorine level.

The best chlorine for your spa is a granular “Dichlor” compound. It dissolves quickly in moving water and has a nearly neutral pH. Add chlorine while jets are running and let the jets run for ½ hour. Generally, heavily contaminated water can be disinfected using large chlorine doses, in the range of 8-10 ppm, but a more practical method is to drain the spa and refill it with fresh water.

The effectiveness of chlorine is decreased when the cover is left off the water for two reasons: (1) sunlight decays chlorine rapidly, and (2) organic debris is blown into the spa and taxes the effectiveness of the chlorine. In addition, the higher the water temperature, the faster chlorine will decay.

NOTE: Two or more individuals in a spa may reduce the level of sanitizer rapidly.

SUPER CHLORINATION

Super chlorination quickly oxidizes the spa water to burn out wastes such as perspiration, hairspray, lotions, etc. that cannot be removed by the spa filter. This waste build-up reduces the power of the sanitizer, making the water dull and irritating to the eyes and skin. It may also produce an odor. When this occurs, the free chlorines have become chloramines which are much less effective as a sanitizer. This can be eliminated by super chlorination as needed. An application of 5 times the normal chlorine dosage will act as an adequate treatment.

SHOCK TREATMENTS (POTASSIUM PEROXYMONOSULFATE)

Even with regular sanitization, shock treatment may be necessary on occasion. Shock is recommended over super chlorination because it does not add additional sanitizer to the water. It is also effective in oxidizing wastes and will reduce chloramines or bromamines. Follow the manufacturer's instructions listed on the label.

OZONE

Your spa maybe equipped with an ozone generator. L.A. Spas requires that only their ozone generator be used on spas due to the design of the mixing chamber system. Ozone related failures due to use of other manufacturer's ozone generators will not be covered under warranty. Ozone delivery occurs when the circulation pump is running.

UV

Equipping your spa with an Ozone system that includes the Ozonator or UV Sanitizer is a smart decision. The use of ozone in conjunction with spa sanitizing and water balancing chemicals helps to provide you with a cleaner, healthier spa, reduces chemical usage, and protects your skin from chemically induced irritation.

WATER TESTING

It is recommended that you test your spa water regularly with an accurate test kit or test strip. These are available from your local authorized American Whirlpool dealer. Be sure to follow the chemical manufacturer's instructions for chemical use.

STAIN AND SCALE INHIBITOR

Staining and scaling may be a common problem in spas. Because the water is hot, scale may be deposited more quickly. The circulation of water can cause the erosion of metals from spa equipment, which can stain interior surfaces. A weekly dose of a stain and scale fighter will help control these problems.

A sequestering agent, such as Metal Gone, can be added to the spa water when filling a spa (for the first time or when draining and refilling). This will help eliminate metals in your water and increases the life of your spa equipment.

FOAM INHIBITOR

Soap residue from a user's body, hair, and swimsuit combined with rapid circulation of spa water may cause foaming in your spa. Foam inhibitors will suppress foam, but cannot remove soap from the water. When foaming occurs, a shock treatment can oxidize the soap in your water and help prevent this condition. If foam remains a problem, change the water. Consult the directions on the foam inhibitor container for usage amount. When adding chemicals to your spa water, add to the center of the spa with the pump operating. Never add chemicals directly into the skimmer. Make sure the water is heated. Never add chemicals to cold water, as this will affect the chemical reaction.

Store all chemicals in a cool dry location and in such a manner to prevent contact by children or pets.

You should consult your local authorized American Whirlpool dealer prior to any chemical use.

KEEPING YOUR WATER CLEAN AND SAFE

Monday		Friday	
Test:	Bromine/Chlorine pH Total Alkalinity	Test:	Bromine/Chlorine pH Total Alkalinity
Adjust:	Follow steps 1 - 4	Adjust:	Follow steps 1 - 4
Add:	Stain & Scale control	Add:	Stain & Scale control

Step 1: Adjust total alkalinity – ideal range is between 130-160. Test water, follow directions on manufacturer’s label, and add the required amount of spa chemicals with the jets on. Wait 30 minutes before performing additional tests.

Step 2: Adjust pH – ideal range is between 7.2-7.6. Test water, follow directions on manufacturer’s label, and add the required amount of spa chemicals with the jets on.

Step 3: Adjust bromine/chlorine – ideal range is between 2-3 ppm chlorine and 3-5 ppm bromine (4-6 ppm for heavy spa usage). Fill bromine floater or adjustable feeder and shock spa as necessary.

Step 4: Stain and scale control – once a week add the required amount of spa chemicals with jets on.

NOTE: The chemical chart above is a simple schedule for moderate spa use. Depending on the usage, chemical balancing may be required more often.

SPA CARE

FILTER CLEANING

Always make sure the spa is off before removing and cleaning the filter cartridges. We recommend the cartridges be cleaned every two weeks to avoid a decrease in jet performance. On initial start-up, the filters should be cleaned every other day for the first two weeks of operation.

To clean the filter bags, place them into the washing machine. Use ¼ cup of bleach, wash with warm water in gentle cycle. Do not machine dry.

CARE FOR SPA SURFACE

American Whirlpool spas have a very high quality finish. Stains and dirt will generally not adhere to the surface. After draining the spa, wipe the surface with a soft damp cloth (or sponge) using household soap or liquid detergent. Stubborn dirt and stains maybe removed by using Spic & Span adequately dissolved in water. Be sure to rinse detergent well as this will cause suds when refilling the spa.

CARE FOR SPA PILLOWS

Due to the nature of a spa's environment, spa pillows are exposed to chemicals, which in turn can affect the pillow's useful life. To be extra careful, we encourage you to always remove the spa pillows when adding chemical treatments to your spa's water. The spa pillows can then be re-installed to the spa when the chemical level is at the recommended parts per million (PPM). For most spas, this is between 3-5 PPM.

Furthermore, spa pillows should be cleaned regularly. To do this, remove the pillows from your spa, and then wipe the pillows with a soft damp cloth using mild dish washing soap and warm water. Rinse off the excess soapy water, and then simply re-install the pillows onto your spa.

CARE OF SPA CABINET

Your spa cabinet requires little or no maintenance of any kind. To clean, simply wipe cabinet with a clean towel and mild detergent soap solution.

CAUTION – Do not use any cleaning products containing abrasives or solvents. Do not stain, paint or otherwise cover the cabinet with any substance since these can and will damage the ultraviolet clear coat used on the surface of the spa skirt and void your warranty.

CARE FOR WEATHERSHIELD SPA COVER

Your WeatherShield spa cover is an extremely durable foam insulated product. When your spa is not in use, it is highly recommended that the cover tie downs always be utilized to discourage unsupervised children from entering the spa and to minimize heat loss. See your WeatherShield spa cover Owner's Manual for proper installation instructions.

Spa covers should be cleaned regularly. To clean the cover, simply wipe the cover using a clean towel with a mild detergent or soap solution. Do not use any cleaning products containing abrasives or solvents since these could damage the cover surface and void your warranty. You may apply fabric protectant on the spa cover. Use one specified by your spa dealer only. This will provide a protective coating for your spa cover. Follow the instructions on the label of the protectant product. Lastly, consult your American Whirlpool Authorized Dealer for further questions regarding your spa cover.

DRAINING THE SPA

1. Turn power off to spa.
2. Attach a hose to the external drain located on the front panel or corner of the bottom pan. Open the valve and allow the water to drain away from the spa.
3. Clean the spa surface (see care of spa surface in this section).
4. Refill spa, and follow initial start-up procedures to reheat the spa.

SPECIAL COLD WEATHER INSTRUCTIONS (WINTERIZING)

Winter can be one of the most enjoyable times of the year to enjoy your spa. As it is difficult to get water out of the plumbing lines, WE DO NOT RECOMMEND DRAINING YOUR SPA FOR THE WINTER. However, if you decide not to use your spa during the winter, we recommend you winterize as follows:

1. If you drain your spa, turn off the main power to the spa. Drain as completely as possible. You may want to use a wet-vacuum or high-pressure blower to evacuate as much water as possible.
2. When the spa is completely empty, leave the hose bib open and open the pump drain plug located on the bottom side of the front end of the pump. Loosen all pump unions and fittings to allow air and water to expand freely within the system. This should help prevent water from freezing and damaging pipes and fittings. The idea is to try to eliminate water from any sealed areas in

Should you have a heavy snowfall during the winter months, you may want to build a protective cover cap for the spa cover. This may be done with a ½" or ¾" piece of plywood and a few 2" x 4" cross members.

Although your spa is equipped with an automatic freeze protection, a power outage can cause your spa equipment system to freeze quickly. During freezing conditions, check your spa frequently to ensure proper operation. Be sure to check your spa after any power failure to ensure the spa is operational.

For additional information on winterizing your spa, contact your local American Whirlpool dealer.

THERMAL CREEP

Your spa is manufactured with energy-efficient components and systems that capture heat generated by the equipment, then transfers that heat back to the spa water. In warmer weather or in situations with extended run times, Thermal Creep may occur. Thermal Creep is a condition whereby the actual water temperature is higher than the set temperature. To manage "Thermal Creep" you may:

1. Vent your cover: Newer covers have removable center seal padding. To remove this padding, open the Velcro on one side of the vinyl pouch and slide the white padding out. If your spa does not have removable center seal padding, you may instead place a folded cloth about ¾" (2cm) thick under all four corners of the cover before you lock it down. Opening the cover at night will also quickly cool the water down if desired.
2. Open all air controls.
3. Set your filtration cycles to run during the cooler times of the day or at night.
4. Reduce the length of your filter cycles.
5. Visit your local dealer for additional guidance.

Thermal Creep only occurs in well-insulated hot tubs. It is not an indication that something is wrong with your spa or the equipment.

WARRANTY SERVICE INFORMATION

Your American Whirlpool warranty gives you specific coverage. Be sure you read your warranty carefully and return your completed warranty card to your American Whirlpool dealer upon completion of installation. You may also register your new spa's warranty online at: <https://americanwhirlpool.com>

PLEASE NOTE: The warranty does not cover problems resulting from misuse, abuse, or neglect, and it does not cover problems caused by improper installation or perceived problems caused by failure to read the spa owner's manual.

TROUBLESHOOTING

HEATING SYSTEM

Symptom	Problem	Corrective Action
Spa water cold / spa not heating	<ol style="list-style-type: none"> 1. Temperature setting is not at user select. Power reset caused default setting 2. Spa in economy mode 3. Dirty filters 4. Air lock 5. Jets closed obstructing flow 6. Pump gate valve closed 7. Equipment malfunction 	<ol style="list-style-type: none"> 1. Increase temperature 2. Reset to standard mode. 3. Clean filters 4. Prime pump (see page 10) 5. Open jets 6. Open gate valve 7. Call for service
Spa water too warm / spa heating above set point	<ol style="list-style-type: none"> 1. Temperature setting too high 2. Too much filtration 3. Thermal Creep 4. Dirty filters 5. Overheat or high limit occurred 6. Equipment malfunction 	<ol style="list-style-type: none"> 1. Decrease temperature 2. Reduce the number of filter cycles and/or the filter cycle duration 3. Refer to Thermal Creep Section (p. 48) 4. Clean filters 5. Call for service 6. Call for service
Spa temperature erratic	<ol style="list-style-type: none"> 1. Water level low 2. Spa in economy mode 3. Dirty filters 4. Jets closed obstructing flow 5. Pump gate valve closed 6. Equipment malfunction 	<ol style="list-style-type: none"> 1. Fill with water to 5" (13cm) below the top of spa 2. Reset to standard mode 3. Clean filters 4. Open jets 5. Open gate valve 6. Call for service

WATER SYSTEM

Symptom	Problem	Corrective Action
Pulsating jets	<ol style="list-style-type: none"> 1. Water level low 2. Dirty filters 3. Filter intake / pump intake restricted 4. Pump gate valve closed 5. Equipment malfunction 	<ol style="list-style-type: none"> 1. Fill with water to 5" (13cm) below the top of spa 2. Clean filters 3. Remove obstruction 4. Open gate valve 5. Call for service
No jet action or action is poor	<ol style="list-style-type: none"> 1. Jets are turned off 2. Diverter valve turned 3. Water level low 4. Dirty filters 5. Pump gate valve closed 6. Air lock 	<ol style="list-style-type: none"> 1. Turn jets on by turning jet face 2. Turn the diverter valve clockwise or counterclockwise 3. Fill with water to 5" (13cm) below the top of spa 4. Clean filters 5. Open gate valve 6. Prime pump (see page 26)

ELECTRICAL SYSTEM

Symptom	Problem	Corrective Action
Spa will not turn on in any mode	<ol style="list-style-type: none"> 1. No power 2. Equipment malfunction 	<ol style="list-style-type: none"> 1. Check circuit breaker and/or GFCI 2. Call for service
Spa turns on by itself	<ol style="list-style-type: none"> 1. Normal automatic daily filtration cycle 2. Spa required heat to maintain temperature 3. Freeze protection engaged 4. Equipment malfunction 	<ol style="list-style-type: none"> 1. No action required 2. No action required 3. No action required 4. Call for service
Light is out	<ol style="list-style-type: none"> 1. Automatic time out has shut off light. 2. Burned out light bulb 	<ol style="list-style-type: none"> 1. Press Light key again to start another cycle. 2. Replace light bulb
Pump shuts down unexpectedly while in use	<ol style="list-style-type: none"> 1. Automatic timeout has shut pump off 2. Motor overheated and protective device has shut down pump 	<ol style="list-style-type: none"> 1. Press Jets keys again to start another cycle 2. Allow pump to cool. If the pump does not restart when Jets key is pressed, call for service

ERROR MESSAGES

Message	Corrective Action
Hardware error was detected (Thermal fuse)	Reset power to spa. Check for operations of all pumps and accessories. If error code remains, call for service.
High Limit circuit has tripped!	DO NOT ENTER WATER. Add cold water to spa and let the heater cool down, reset power to spa.
No Flow condition; or No Flow condition for more than 2 hours	Reset power to spa. Make sure that the pump associated to the heater is running. Check and clean filters and reset the power to see if the error message goes away. Air locked, prime the pump (see page 22).
Spa temperature is too high	Remove spa cover. Add cold water.
Temp probes or detection circuit are defective	Reset power to spa, if error code remains, call for service.
Elevated internal temperature	Turn off power to the spa to allow the equipment compartment to cool. If error message occurs again, call for service.
Input voltage issue	Call a certified electrician to verify power line quality.

ERROR CODES

Error Code	Description	Corrective Action
Hr	A hardware error was detected in the control pack.	Reset power to spa. Check for operations of all pumps and accessories. If error code remains, call for service.
HL	The high limit circuit has tripped.	DO NOT ENTER WATER. Add cold water to spa and let the heater cool down, reset power to spa.
FLO	Occurs when no flow is detected at the heater.	Reset power to spa. Make sure that the pump associated with the heater is running. Check and clean filters and reset the power to see if error message goes away. Air locked, prime the pump (see page 22). RUNNING THE SPA WITHOUT FILTERS IS FOR TESTING PURPOSES ONLY, NEVER USE SPA WITHOUT FILTERS.

Prr	Temperature probe is defective	Reset power to spa, If error code remains, call for service.
AOH	Temperature conditions inside the equipment area are above 194°F	Turn off power to the spa to allow equipment compartment to cool. If error message occurs again, call for service.

SAFETY SIGN

The safety sign enclosed with your Owner's Manual should be permanently installed where visible to all users of the spa. This sign is adhesive backed and includes four screws for mounting the sign on rough surfaces. It is very important that you, as a spa owner, review the important safety instructions and warnings before you operate your spa. It is equally important that you instruct all users, even occasional ones, as to the warnings associated with spa use.

You may obtain additional signs by contacting :

USA: MAAX Spas Industries Corp..
Customer Service
25605 South Arizona Avenue
Chandler, Arizona 85248
<https://maaxspas.com>

LIMITED WARRANTY SUMMARY

Please refer to the Warranty Card included with your product for complete warranty information. In order to receive prompt warranty service, you must return your warranty card, completed with model and serial number, to your dealer immediately upon completion of the spa installation. MAAX Spas Industries Corp. provides a limited warranty to our customers. It applies to the spa structure, surface, plumbing, pumps, heater, blower, and controls. The limited warranty does not cover damage resulting from improper maintenance, improper installation, misuse, abuse, accident, fire, normal wear and tear, or improper water maintenance. Unauthorized modifications of the spa may void the warranty. Replacement cost associated with transportation, removal and reinstallation are the sole responsibility of the spa owner. MAAX Spas Industries Corp., reserves the right to make changes in design or material of its products at any time without incurring liability. This limited warranty applies to the first retail purchaser and terminates upon any transfer of ownership.

COPYRIGHTS AND TRADEMARKS

©Copyright 2022 MAAX Spas Industries Corp.. All rights reserved. No parts of this publication may be reproduced, stored in a retrieval system, or transmitted, in any form or by any means (electronic, mechanical, photocopying, recording or otherwise), without prior written permission.

Disclaimer:

The information in this manual is accurate to the best of MAAX Spas Industries Corp.'s knowledge. However, MAAX Spas Industries Corp. assumes no responsibility for errors or omissions. Nor is any liability assumed for damages resulting from use of the information contained herein. Specifications subject to change without notice. Spas shown at variable percentage of actual size.

Congratulations on your purchase of a MAAX® Spas product. Your Owner's Manual provides installation, operation and maintenance instructions.

Please review it and keep it for future references.

Save These Instructions

Owner's Record Information

Date Purchases : _____

Purchased From : _____

Phone Number : _____

Installed By : _____

Serial Number : _____ Model : _____

